

# Electrical Energy Conservation and Auditing

By

**Dr. Yogesh Kumar Nayak**

Assistant Professor

Department of Electrical Engineering

Government Collage of Engineering, Keonjhjar-758002

### Module III: (06 Hours)

**Illumination: Illumination, luminous flux, lumen, luminous intensity, candela power, brightness, glare, types of lighting (incandescent, CFL, and LED), requirements of lux for various purposes, determine the method of lighting, select the lighting equipment's, and calculate the lighting parameters.**

**Illumination**, an observable property and effect of light, may also refer to

- **Lighting**, the use of light sources
- Illumination (image), the use of light and shadow in art
- Illuminated manuscript, the artistic decoration of hand-written texts
- Global illumination, algorithms used in 3D computer graphics

### 3.1 Introduction

Lighting is an essential service in all the industries. The power consumption by the industrial lighting varies between 2 to 10% of the total power depending on the type of industry. Innovation and continuous improvement in the field of lighting, has given rise to tremendous energy saving opportunities in this area.

Lighting is an area, which provides a major scope to achieve energy efficiency at the design stage, by incorporation of modern energy efficient lamps, luminaires and gears, apart from good operational practices.

**Light:** It is defined as the radiation energy from a hot body which produces the visual sensation upon the human eye. It is usually denoted by  $Q$ , expressed in lumen-hours and is analogous to watt-hour.

**Luminous flux:** it is defined as the total quantity of light energy emitted per second from a luminous body. It is represented by symbol  $F$  and is measured in lumens. The concept of luminous flux helps us to specify the output and efficiency of a given light source.

**Luminous intensity:** luminous intensity in any given direction is the luminous flux emitted by the source per unit solid angle, measured in the direction in which the intensity is required. It is denoted by symbol  $I$  and is measured in candela(cd) or lumens/steradian.

If  $F$  is the luminous flux radiated out by source within a solid angle of  $\omega$  steradian in any particular direction then  $I = F / \omega$  lumens/steradian or candela (cd).

**Lumen:** The lumen is the unit of luminous flux and is defined as the amount of luminous flux given out in a space represented by one unit of solid angle by a source having an intensity of one candle power in all directions.

$$\text{Lumens} = \text{candle power} \times \text{solid angle} = cp \times \omega$$

Total lumens given out by source of one candela are  $4\pi$  lumens.

**Candle power:** Candle power is the light radiating capacity of a source in a given direction and is defined as the number of lumens given out by the source in a unit solid angle in a given direction. It is denoted by a symbol **C.P.**

$$C.P. = \text{lumens}/\omega$$

**Illumination:** When the light falls upon any surface, the phenomenon is called the illumination. It is defined as the number of lumens, falling on the surface, per unit area. It is denoted by symbol **E** and is measured in lumens per square meter or meter-candle or lux.

If a flux of **F** lumens falls on a surface of area **A**, then the illumination of that surface is  
 **$E = F/A$  lumens/m<sup>2</sup> or lux**

**Lux or meter candle:** It is the unit of illumination and is defined as the luminous flux falling per square meter on the surface which is everywhere perpendicular to the rays of light from a source of one candle power and one meter away from it.

**Foot candle:** It is also the unit of illumination and is defined as the luminous flux falling per square foot on the surface which is everywhere perpendicular to the rays of light from a source of one candle power and one foot away from it.

$$1 \text{ foot-candle} = 1 \text{ lumen/ft}^2 = 10.76 \text{ meter candle or lux}$$

**Candle:** It is the unit of luminous intensity. It is defined as 1/60 th of the luminous intensity per cm<sup>2</sup> of a black body radiator at the temperature of solidification of platinum (2,043 °K).

**Mean horizontal candle power: (M.H.C.P)** It is defined as the mean of candle powers in all directions in the horizontal plane containing the source of light.

**Mean spherical candle power: ( M.S.C.P)** It is defined as the mean of the candle powers in all directions and in all planes from the source of light.

**Mean hemi-spherical candle power: (M.H.S.C.P)** It is defined as the mean of candle powers in all directions above or below the horizontal plane passing through the source of light.

**Reduction factor:** Reduction factor of a source of light is the ratio of its mean spherical candle power to its mean horizontal candle power.

$$\text{reduction factor} = M.S.C.P./M.H.C.P.$$

**Lamp efficiency:** It is defined as the ratio of the luminous flux to the power input. It is expressed in lumens per watt.

**Specific consumption:** It is defined as the ratio of the power input to the average candle power. It is expressed in watt per candela.

**Brightness:** When the eye receives a great deal of light from an object we say it is bright, and brightness is an important quantity in illumination. It is all the same whether the light is produced by the object or reflected from it.

Brightness is defined as the luminous intensity per unit projected area of either a surface source of light or a reflecting surface and is denoted by **L**.

If a surface area A has an effective luminous intensity of I candelas in a direction  $\theta$  to the normal, then the brightness (luminance) of that surface is

$$L = I/a \cos\theta$$

The unit of brightness is candela/m<sup>2</sup> (nits), candela/cm<sup>2</sup> (stilb) or candela/ft

**Glare:-** The size of the opening of the pupil in the human eye is controlled by its iris. If the eye is exposed to a very bright source of light the iris automatically contracts in order to produce the amount of light admitted and prevent damaged to retina this reduces the sensitivity, so that other objects within the field of vision can be only imperfectly seen.

In other words glare maybe defined as brightness with in the field of vision of such a character as the cause annoyance discomfort interference with vision.

**Space height ratio:-** it is defined as the ratio of distance between adjacent lamps and height of their mountings.

$$\text{Space to height ratio} = \frac{\text{horizontal distance between two adjacent lamps}}{\text{mounting height of lamps above working plane}}$$

**Utilization factor or co-efficient of utilization:-** It is defined as the ratio of total lumens reaching the working plane to total lumens given out by the lamp.

$$\text{Utilization Factor} = \frac{\text{total lumens reaching the working plane}}{\text{total lumens given out by the lamp}}$$

**Maintenance factor:** Due to accumulation of dust, dirt and smoke on the lamps, they emit less light than that they emit when they are new ones and similarly the walls and ceilings e.t.c. after being covered with dust, dirt and smoke do not reflect the same output of light, which is reflected when they are new. Lumens

The ratio of illumination under normal working conditions to the illumination when the things are perfectly clean is known as maintenance factor.

$$\text{Maintenance Factor} = \frac{\text{illumination under normal working conditions}}{\text{illumination when every thing is clean}}$$

**Depreciation factor:** this is merely reverse of the maintenance factor and is defined as the ratio of the initial meter-candles to the ultimate maintained metre-candles on the working plane. Its value is more than unity.

**Waste light factor:** Whenever a surface is illuminated by a number of sources of light, there is always a certain amount of waste of light on account of over-lapping and falling of light outside at the edges of the surface. The effect is taken into account by multiplying the theoretical value of lumens required by 1.2 for rectangular areas and 1.5 for irregular areas and objects such as statues, monuments etc.

**Absorption factor:** In the places where atmosphere is full of smoke fumes, such as in foundries, there is a possibility of absorption of light. The ratio of total lumens available after absorption to the total lumens emitted by the source of light is called the absorption factor. Its value varies from unity for clean atmosphere to 0.5 for foundries.

**Beam factor:** the ratio of lumens in the beam of a projector to the lumens given out by lamps is called the beam factor. This factor takes into the account the absorption of light by reflector and front glass of the projector lamp. Its value varies from 0.3 to 0.6.

**Reflection factor:** When a ray of light impinges on a surface it is reflected from the surface at an angle of incidence, as shown in the following figure. A certain portion of incident light is absorbed by the surface. The ratio of reflected light to the incident light is called the **reflection factor**. It's value always less than unity.

**Plane angle:** A plane angle is the angle subtended at a point in a plane by two converging lines. It is denoted by the Greek letter ' $\theta$ ' (theta) and is usually measured in degrees or radians.

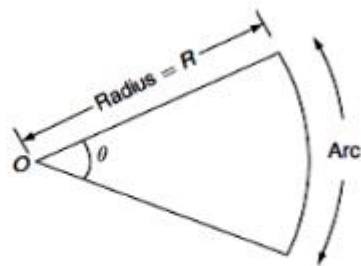

$$\theta = \frac{\text{arc}}{\text{radius}} \text{ radians}$$

One radian is defined as the angle subtended by an arc of a circle whose length is equal to the radius of the circle.

**Solid angle:** Solid angle is the angle subtended at a point in space by an area, i.e., the angle enclosed in the volume formed by numerous lines lying on the surface and meeting at the point. It is usually denoted by symbol ' $\omega$ ' and is measured in steradian.

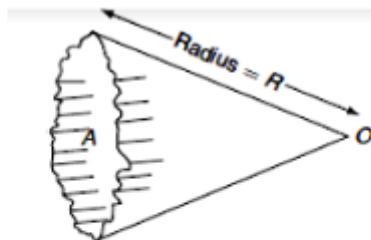

$$\omega = \frac{\text{area}}{(\text{radius})^2} = \frac{A}{r^2}$$

The largest solid angle subtended at a point is that due to a sphere at its centre. If  $r$  is the radius of any sphere, its surface area is  $4\pi r^2$  and the distance of its surface area from the centre is  $r$ , therefore, solid angle subtended at its centre by its surface,

$$\omega = \frac{4\pi r^2}{(r)^2} = 4\pi \text{ steradians}$$

**Example 1:** A 200-V lamp takes a current of 1.2 A, it produces a total flux of 2,860 lumens. Calculate:

1. the MSCP of the lamp and
2. the efficiency of the lamp.

**Solution:**

Given  $V = 200 \text{ V}$ ,  $I = 1.2 \text{ A}$ , flux = 2,860 lumens.

$$\text{MSCP} = \frac{\text{total flux}}{4\pi} = \frac{2860}{4\pi} = 227.59.$$

Lamp efficiency = lumens flux/power input =  $2860/(200 \times 1.2)$  lumens/watt

**Example 2:** A room with an area of  $6 \times 9 \text{ m}$  is illustrated by ten 80-W lamps. The luminous efficiency of the lamp is 80 lumens/W and the coefficient of utilization is 0.65.

Find the average illumination.

**Solution:**

Room area =  $6 \times 9 = 54 \text{ m}^2$ .

Total wattage =  $80 \times 10 = 800 \text{ W}$ .

Total flux emitted by ten lamps =  $80 \times 800 = 64,000 \text{ lumens}$ .

Flux reaching the working plane =  $64,000 \times 0.65 = 41,600 \text{ lumens}$ .

$$\therefore \text{Illumination, } E = \frac{\phi}{A} = \frac{41,600}{54} = 770.37 \text{ lux.}$$

### Laws of Illumination

Mainly there are two laws of illumination.

1. Inverse square law.
2. Lambert's cosine law.

**1. Inverse square law:** This law states that 'the illumination of a surface is inversely proportional to the square of distance of the surface from the source of light.'

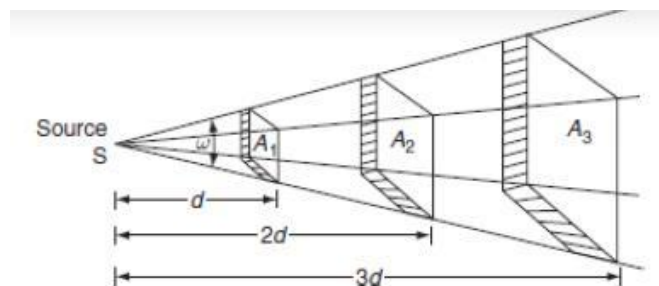

Let, 'S' be a point source of luminous intensity 'I' candela, the luminous flux emitting from source crossing the three parallel plates having areas  $A_1$ ,  $A_2$ , and  $A_3$  square meters, which are separated by a distances of  $d$ ,  $2d$ , and  $3d$  from the point source respectively as shown in Fig.

For area  $A_1$ , solid angle  $\omega = A_1/d^2$

Luminous flux reaching the area  $A_1 = \text{luminous intensity} \times \text{solid angle}$   
 $= I * \omega = I * A_1/d^2$

Illumination ' $E_1$ ' on the surface area ' $A_1$ ' is:

$$E_1 = \text{flux/area} = I * A_1/d^2 * 1/A_1$$

$$E_1 = I/d^2 \text{ lux}$$

Similarly, illumination ' $E_2$ ' on the surface area  $A_2$  is:

$$E_2 = I/(2d)^2 \text{ lux}$$

Similarly, illumination ' $E_3$ ' on the surface area  $A_3$  is:

$$E_3 = I/(3d)^2 \text{ lux}$$

From above equations

$$E_1 : E_2 : E_3 = I/d^2 : I/(2d)^2 : I/(3d)^2$$

Hence, from Equation, illumination on any surface is inversely proportional to the square of distance between the surface and the source.

**2. Lambert's cosine law:** This law states that illumination,  $E$  at any point on a surface is directly proportional to the cosine of the angle between the line of flux AND the normal at that point.

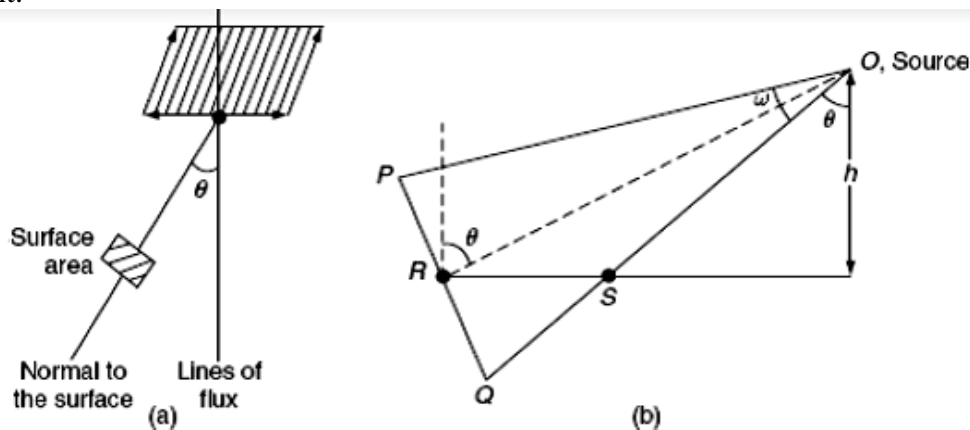

Let us assume that the surface is inclined at an angle ' $\theta$ ' to the lines of flux as shown in Fig. (a)

PQ = The surface area normal to the source and inclined at ' $\theta$ ' to the vertical axis.

RS = The surface area normal to the vertical axis and inclined at an angle  $\theta$  to the source 'O'.

$$PQ = RS \cos \theta.$$

$$\therefore \text{The illumination of the surface } PQ, E_{PQ} = \frac{\text{flux}}{\text{area of } PQ}$$

$$= \frac{I \times \omega}{\text{area of } PQ} = \frac{I}{\text{area of } PQ} \times \frac{\text{area of } PQ}{d^2} \quad [\because \omega = \text{area}/(\text{radius})^2]$$

$$= \frac{I}{d^2}.$$

$$\begin{aligned} \therefore \text{The illumination of the surface } RS, E_{RS} &= \frac{\text{flux}}{\text{area of } RS} = \frac{\text{flux}}{\text{area of } PQ / \cos \theta} \\ & \quad [\because PQ = RS \cos \theta] \\ &= \frac{I}{d^2} \cos \theta. \end{aligned}$$

From Fig (b)

$$\begin{aligned} \cos \theta &= h/d \\ \text{or } d &= h/\cos \theta \end{aligned}$$

Substitute value of  $d$  in above equation

$$\therefore E_{RS} = \frac{I}{(h/\cos \theta)^2} \times \cos \theta = \frac{I}{h^2} \cos^3 \theta$$

$$\therefore E_{RS} = \frac{I}{d^2} \cos \theta = \frac{I}{h^2} \cos^3 \theta$$

where  $d$  is the distance between the source and the surface in m,  $h$  is the height of source from the surface in m, and  $I$  is the luminous intensity in candela.

Hence, above Equation is also known as ‘cosine cube’ law. This law states that the illumination at any point on a surface is dependent on the cube of cosine of the angle between line of flux and normal at that point.

*Note - From the above laws of illumination, it is to be noted that inverse square law is only applicable for the surfaces if the surface is normal to the line of flux. And Lambert's cosine law is applicable for the surfaces if the surface is inclined an angle ‘ $\theta$ ’ to the line of flux.*

**Color Rendering Index (CRI):** is a measure of the effect of light on the perceived color of objects. To determine the CRI of a lamp, the color appearances of a set of standard color chips are measured with special equipment under a reference light source with the same correlated color temperature as the lamp being evaluated. If the lamp renders the color of the chips identical to the reference light source, its CRI is 100. If the color rendering differs from the reference light source, the CRI is less than 100. A low CRI indicates that some colors may appear unnatural when illuminated by the lamp.



## 3.2 Types of lighting (incandescent, CFL, and LED):

### Lamps

Lamp is equipment, which produces light. The most commonly used lamps are described briefly as follows:

- **Incandescent lamps:**

Incandescent lamps produce light by means of a filament heated to incandescence by the flow of electric current through it. The principal parts of an incandescent lamp, also known as GLS (General Lighting Service) lamp include the filament, the bulb, the fill gas and the cap.

- **Reflector lamps:**

Reflector lamps are basically incandescent, provided with a high quality internal mirror, which follows exactly the parabolic shape of the lamp. The reflector is resistant to corrosion, thus making the lamp maintenance free and output efficient.

- **Gas discharge lamps:**

The light from a gas discharge lamp is produced by the excitation of gas contained in either a tubular or elliptical outer bulb. The most commonly used discharge lamps are as follows:

- Fluorescent tube lamps (FTL)
- Compact Fluorescent Lamps (CFL)
- Mercury Vapour Lamps
- Sodium Vapour Lamps
- Metal Halide Lamps

- **Light Emitting Diode LED Lamp:**

A **light**-emitting diode (**LED**) is a semiconductor **light** source that emits **light** when current flows through it. Electrons in the semiconductor recombine with electron holes, releasing energy in the form of photons. ... The first visible-**light** LEDs were of low intensity and limited to red.

### 3.2.1 Incandescent lamps:

The electrical light source which works on the principle of **incandescent phenomenon** is called **Incandescent Lamp**. In other words, the lamp working due to glowing of the filament caused by electric current through it, is called **incandescent lamp**.

#### History of Incandescent Lamp

It is normally considered that **Thomas Edison** was the inventor of the incandescent lamp, but the actual history was not like that. There were numbers of scientists who worked and designed prototype for the incandescent lamp before Edison did. One of them was British physicist **Joseph Wilson Swan**. From the record, it is found that he got the first patent for the incandescent lamp in 1878. Later Edison and Swan merged to produce incandescent lamps in commercial scale in 1880.

## How do Incandescent Lamps Work?

When an object is made hot, the atoms inside the object become thermally excited. If the object does not melt, the outer orbit electrons of the atoms jump to higher energy level due to the supplied energy. The electrons on these higher energy levels are not stable, they again fall back to lower energy levels. While falling from higher to lower energy levels, the electrons release their extra energy in a form of photons. These photons are then emitted from the surface of the object in the form of electromagnetic radiation.

This radiation will have different wavelengths. A portion of the wavelengths is in the visible range of wavelengths, and a significant portion of wavelengths are in infrared range. The electromagnetic wave with wavelengths within the range of infrared is heat energy and the electromagnetic wave with wavelengths within visible range is light energy.

Incandescent means producing visible light by heating an object. An **incandescent lamp** works in the same principle. The simplest form of the artificial source of light using electricity is an incandescent lamp. Here we use electric current to flow through a thin and fine filament to produce visible light. The current rises the temperature of the filament to such extent that it becomes luminous.

### Construction of Incandescent Lamp

The filament is attached across two lead wires. One lead wire is connected to the foot contact and other is terminated on the metallic base of the bulb. Both of the lead wires pass through glass support mounted at the lower middle of the bulb. Two support wires also attached to glass support, are used to support filament at its middle portion. The foot contact is isolated from metallic base by insulating materials. The entire system is encapsulated by a colored or phosphore coated or transparent glass bulb. The glass bulb may be filled with inert gases or it is kept vacuum depending upon rating of the incandescent lamp.

The filament of **incandescent lamps** is air-tightly evacuated with a glass bulb of suitable shape and size. This glass bulb is used to isolate the filament from surrounding air to prevent oxidation of filament and to minimize convection current surrounding the filament hence to keep the temperature of the filament high.

The glass bulb is either kept vacuum or filled with inert gases like argon with a small percentage of nitrogen at low pressure. Inert gases are used to minimize the evaporation of filament during service of the lamps. But due to convection flow of inert gas inside the bulb, there will be greater chances of losing the heat of filament during operation.

Again vacuum is a great insulation of heat, but it accelerates the evaporation of filament during operation. In the case of gas-filled incandescent lamps, 85% of argon mixed with 15% of nitrogen is used. Occasionally krypton can be used to reduce filament evaporation because the molecular weight of krypton gas is quite higher.

But it costs greater. At about 80% of atmospheric pressure, the gasses are filled into the bulb. Gas is filled in the bulb with the rating more than 40 W. But for less than 40 W bulb; there is no gas used.

The various parts of an incandescent lamp are shown below.

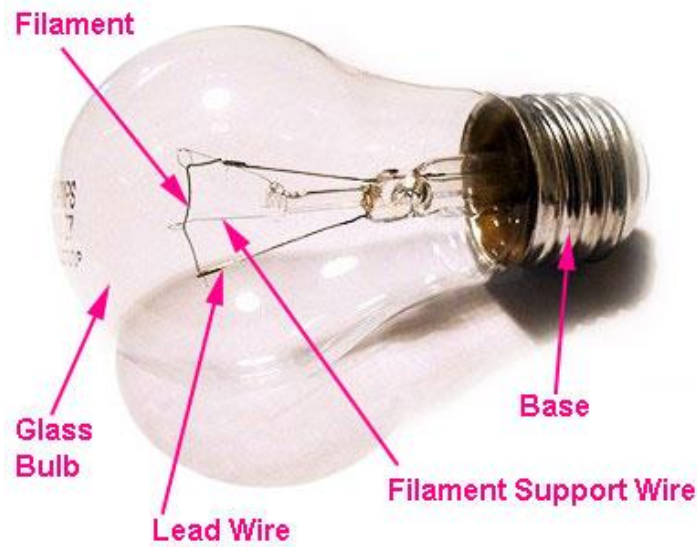

### **Filament of Incandescent Lamp**

In present days, **incandescent lamps** are available in different wattage ratings such as 25, 40, 60, 75, 100 and 200 watts etc. There are different shapes of bulbs, but basically, all are rounded in shape. There are mainly three materials used for producing the filament of incandescent lamps, and these are carbon, tantalum, and tungsten. Carbon was previously used for filament material, but presently tungsten is used most for the purpose.

The melting point of carbon filament is about  $3500^{\circ}\text{C}$ , and the operating temperature of this filament is about  $1800^{\circ}\text{C}$  hence the chance of evaporation is quite less. Because of that carbon filament, incandescent lamps are free from darkening due to filament evaporation. Darkening of filament lamp occurs when molecules of filament material are deposited on the inner wall of the glass bulb due to evaporation of filament during operations.

This darkening becomes prominent after the long life span of the lamp. The efficiency of carbon filament lamp is not good it is about 4.5 lumens per watt. Tantalum was used as the filament, but its efficiency is much poor, it is about 2 lumens per watt. This is because tantalum is very rarely used as filament element.

The most widely used filament material now a day is tungsten because of its high luminous efficacy. It can give 18 lumens per watt when it operates at  $2000^{\circ}\text{C}$ . This efficacy can be up to 30 lumens per watt when it operates at  $2500^{\circ}\text{C}$ . The high melting point is a major criterion for filament material as it has to work at very high temperature without being evaporated.

Although tungsten has the little bit poorer melting point than that of carbon but still tungsten is more preferable as filament material. This is because of high operating temperatures which makes tungsten much luminous efficient. The mechanical strength of tungsten filament is quite high to withstand mechanical vibrations.

## Life Span of Incandescent Lamps

Whatever may be the technology of manufacturing, each type of incandescent lamps has some approximate life span. This is because of filament evaporation phenomenon which can be minimized but cannot be avoided completely.

Due to filament evaporation, the glass bulb darkens over a period. Due to filament evaporation the filament becomes thinner which makes the filament less luminous efficient and at last, the filament is broken. As the filament lamps are directly connected to the power supply line, the voltage fluctuations in the line, affect the performance of the bulb.

It is found that luminous efficacy of an incandescent lamp is directly proportional to the square of supply voltage but at the same time, the life span of the lamp is inversely proportional to 13<sup>th</sup> to 14<sup>th</sup> power of supply voltage. The main advantages of incandescent lamps are that these are cheap enough and very suitable for lighting at small areas. But these lamps are not energy efficient and about 90% of input electrical energy is lost as heat.

### Availability of the Incandescent Bulbs in the Market

There are various attractive shapes and sizes of the bulbs available in the market. PS30 lamps have a pear shape, T12 bulb is tubular with diameter 1.5 inch, R40 bulb is with reflector bulb envelope with a diameter of 5 inches. Based on availability of wattage the bulbs are common in the market with 25, 40, 60, 75, 100, 150 and 200W etc. We can follow the table below to get important data about the **incandescent lamp**.

Watts	Filament Temperature (K)	Initial Lumens	Initial Lumen/Watt	Life (H)	Uncoiled filament length (cm)	Filament Diameter (µm)	% lumen Depreciation
25	2560	235	9.4	2500	56.4	30.5	79
40	2740	455	11.4	1500	38.1	33	88
60	2770	870	14.5	1000	53.3	45.7	93
75	2840	1.190	15.9	750	54.9	53.3	92
100	2860	1.750	17.5	750	57.9	63.5	91
200	2890	3.710	18.5	750	63.5	96.5	85
300	2920	5.820	19.4	1000	76.2	129.5	86
500	3000	10.850	21.7	1000	87.4	180.3	89

The principal parts of an incandescent lamp also known as GLS lamp (General Lighting Service lamp) include the filament, the bulb, the fill gas or vacuum and the cap. Incandescent lamps (Figure 8.3 A&B) produce light by means of a wire or filament heated to incandescence by the flow of electric current through it. The filament is enclosed in an evacuated glass bulb filled with gas such as argon, krypton, or nitrogen that helps to increase the brilliance of lamp and to prevent the filament from burning out.

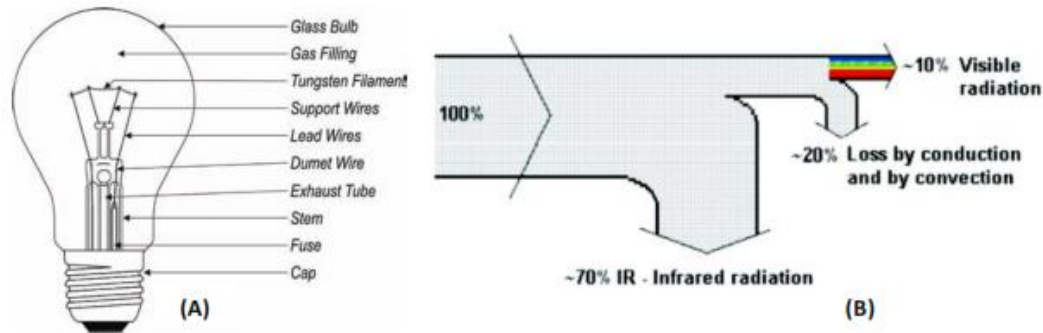
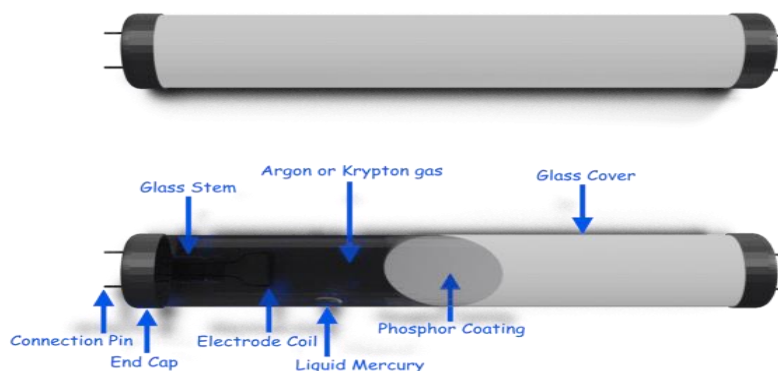

Figure 8.3 Incandescent Lamp and Energy Flow Diagram

### 3.2.2 Fluorescent tube lamps (FTL)

#### What is Fluorescent Lamp?

A **fluorescent lamp** is a low weight mercury vapour lamp that uses fluorescence to deliver visible light. An electric current in the gas energizes mercury vapor which delivers ultraviolet radiation through discharge process and the ultraviolet radiation causes the phosphor coating of the lamp inner wall to radiate visible light.



A fluorescent lamp has changed over electrical energy into useful light energy to a great deal more proficiently than incandescent lamps. The normal luminous viability of fluorescent lighting frameworks is 50 to 100 lumens per watt, which is a few times the adequacy of incandescent lamps with equivalent light yield.

## How does a Fluorescent Lamp work?

Before going through the working principle of a fluorescent lamp, we will first show the circuit of a fluorescent lamp in other words circuit of tube light.

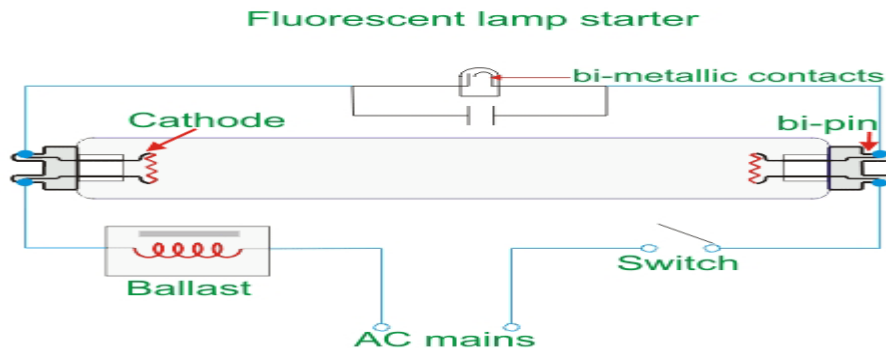

Here we connect one ballast, and one switch and the supply is series as shown. Then we connect the fluorescent tube and a starter across it.

- When we switch ON the supply, full voltage comes across the lamp and as well as across the starter through the ballast. But at that instant, no discharge happens, i.e., no lumen output from the lamp.
- At that full voltage first the glow discharge is established in the starter. This is because the electrodes gap in the neon bulb of starter is much lesser than that of the fluorescent lamp.
- Then gas inside the starter gets ionized due to this full voltage and heats the bimetallic strip. That causes to bend the bimetallic strip to connect to the fixed contact. Now, current starts flowing through the starter. Although the ionization potential of the neon is more than that of the argon but still due to small electrode gap, a high voltage gradient appears in the neon bulb and hence glow discharge gets started first in the starter.
- As soon as the current starts flowing through the touched contacts of the neon bulb of the starter, the voltage across the neon bulb gets reduced since the current, causes a voltage drop across the inductor (ballast). At reduced or no voltage across the neon bulb of the starter, there will be no more gas discharge taking place and hence the bimetallic strip gets cool and breaks away from the fixed contact. At the time of breaking of the contacts in the neon bulb of the starter, the current gets interrupted, and hence at that moment, a large voltage surge comes across the inductor (ballast).

$$V = L \frac{di}{dt}$$

Where,  $L$  is inductance of inductor

and  $\frac{di}{dt}$  is rate of change of current.

- This high valued surge voltage comes across the fluorescent lamp (tube light) electrodes and strikes penning mixture (mixture argon gas and mercury vapor).
- Gas discharge process gets started and continues and hence current again gets a path to flow through the fluorescent lamp tube (tube light) itself. During discharging of penning gas mixture the resistance offered by the gas is lower than the resistance of starter.

- The discharge of mercury atoms produces ultraviolet radiation which in turn excites the phosphor powder coating to radiate visible light.
- Starter gets inactive during glowing of fluorescent lamp (tube light) because no current passes through the starter in that condition.

### Construction of Fluorescent Lamp

A fluorescent tube light consists of

1. a lime glass tube
2. drop of mercury
3. argon gas
4. phosphor coating
5. electrode coils
6. mounting assemblies
7. aluminum cap

Total set up of a lamp requires two bases and electromagnetic ballast or choke coil with a starter.

- The electrode mount assemblies are at both the ends of lamp tube.
- This electrode mounting assembly is almost similar to the stem press unit in the incandescent lamps.
- The electrode is similar to the incandescent lamp filament.
- The filaments of electrodes play both roles as anode and cathode.
- Small plates are attached to the filament to protect the electron bombardment and reduce the wattage loss at both ends.
- The filament is dipped in a mixture of barium, strontium and calcium carbonate. It is baked during manufacturing to become oxides and thus it becomes capable of providing abundance of free electrons easily.
- Liquid mercury is provided inside the lamp bulb.
- Phosphor coating is used on inner wall of the bulb tube.
- At a certain pressure argon gas is filled up inside the tube.
- Two pins at each end are taken out of the lamp body through the cap.

The figure of an electrode is shown below.

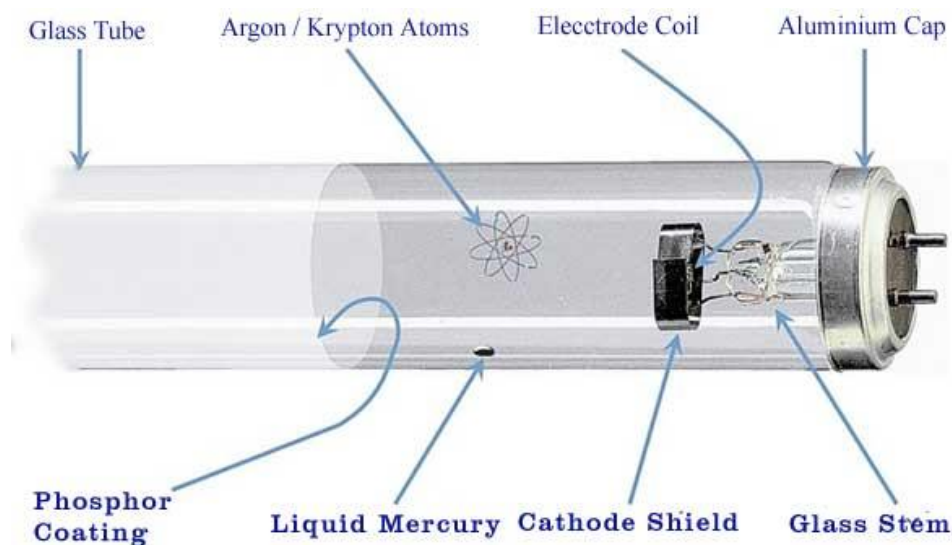



A **fluorescent lamp** tube is loaded with a gas containing low-pressure mercury vapor and argon. The pressure inside the lamp is around 0.3% of environmental pressure. The inward surface of the lamp is coated with a fluorescent (and frequently marginally luminous). This coating is made of shifting mixes of metallic and uncommon earth phosphor salts. The lamp's anodes are normally made of snaked tungsten and typically alluded to as cathodes due to their prime capacity of discharging electrons. For this, they are coated with a blend of barium, strontium, and calcium oxides to have a low thermionic emission temperature. **Fluorescent lamp** tubes are normally straight and long. The length of the commonly used lamp is around 100 millimeters (3.9 in). A few lamps have the tube twisted into a circle, utilized for table lamps or different spots where a more conservative light source is required. Bigger U-shaped lamps are utilized to give the same measure of light in a smaller region. Minimal fluorescent lamps have a few little width tubes joined in a heap of two, four, or six or a little breadth tube curled into a helix, to give a high measure of light yield in little volume.

To **construct a fluorescent tube light** a lime glass tube, drop of mercury, argon gas, phosphor coating and the electrodes with their mount assemblies are required. Total set up of a lamp requires two bases and choke coil with a starter. The electrode mount assembly is almost similar to the stem press unit in the incandescent lamps. The filaments play both roles as anode and cathode. Generally, small plates are attached to the filament to protect it from electron bombardment and to reduce the wattage loss at both ends. The electrode is similar to the incandescent lamp filament. But an exception is that this filament is dipped in a mixture of barium, strontium, and calcium carbonate. It is baked during manufacturing to become oxides and thus it becomes capable of providing the abundance of free electrons easily.

#### Linear tubes

- T12 - 38 mm (1.5" diameter)
- T8 - 25 mm (1" diameter)
- T5 - 16mm (5/8" diameter)
- T2 - 6 mm (1/4" diameter)

#### U-bent tubes

- T12- 38 mm (1.5" diameter)
- T8 - 25 mm (1" diameter)

#### Circular tubes

- T9 - 38 mm (1.5" diameter)
- T5 - 16 mm (5/8" diameter)

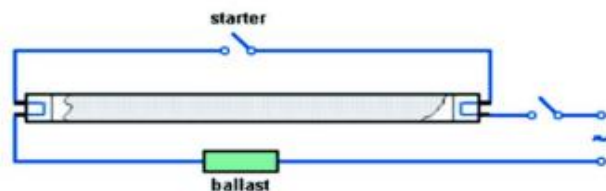

Figure 8.5 (A) Fluorescent Tube Lamp

These four lamps vary in diameter (ranging from 1.5 inches that is 12/8 of an inch for T12 to 0.625 or 5/8 of an inch in diameter for T5 lamps). Efficacy is another area that distinguishes one from another. T5 & T8 lamps offer a 5-percent increase in efficacy over 40-watt T12 lamps, and have become the most popular choice for new installations.



### 3.2.3 Compact Fluorescent Lamps (CFL)

Compact Fluorescent lamps (Figure 8.6) are compact / miniature versions of the linear or circular fluorescent lamps and operate in a very similar way. The luminous flux depends on temperature. CFL's use less power and have a longer rated life compared to an incandescent lamp.

They are designed to replace an incandescent lamp and can fit into most existing light fixtures formerly used for incandescent. CFL's are available in screw type/ pin type which fit into standard sockets, and gives off light that is similar to common fluorescent lamps.



Figure 8.6 Compact Fluorescent Lamp

### 3.2.4 Mercury Vapour Lamps

In case of fluorescent lamp the **mercury vapour** pressure is maintained at lower level such that 60% of the total input energy gets converted into 253.7 nm single line. Again transition of the electrons requires least amount of input energy from a colliding electron. As pressure increases the chance of multiple collisions gets increased.

John Thomas Way developed **Mercury Vapour Lamp** in the year 1860. He tested them in Hammersmith Bridge in London. The modern High Pressure mercury Vapour Lamp is developed in the year 1936 by Philips (no individual Names are Available).

The mercury Vapour lamp is a high intensity discharge lamp and it is also called as hot cathode discharge lamp. The recent development in the High Pressure mercury Vapour Lamp is an ultra pressure lamp operating at about 40atm and its efficiency is more than Sodium Vapour lamp.

#### Construction of High Pressure mercury Vapour Lamp:

A schematic diagram of mercury lamp is shown below. This lamp is containing an inner quartz arc tube and outer borosilicate glass envelope. The quartz tube is able to withstand arc temperature 1300K, whereas the outer tube withstands only 700K.

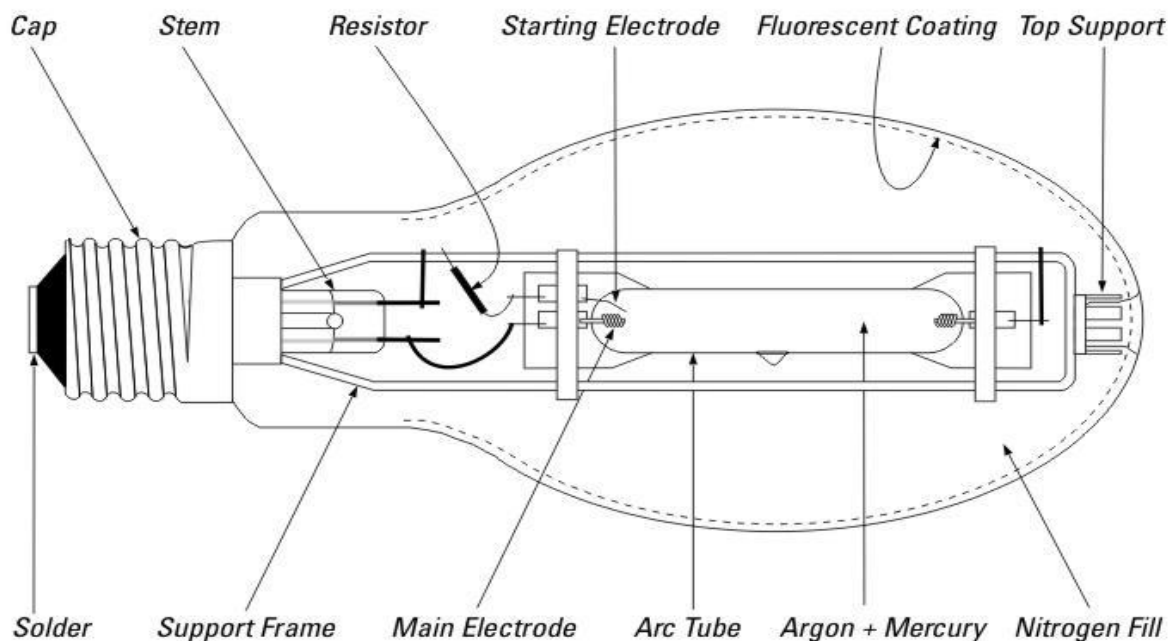

Between two tubes nitrogen gas is filled to provide thermal insulation. This insulation is for to protect the metal parts from oxidation due to higher arc temperature. The arc tube contains the mercury and argon gas. Its operational function is same as the fluorescent lamp. Two main electrodes and a starting electrode (Auxiliary) are inside the arc tube. Each main electrode holds a tungsten rod upon which a double layer of coiled tungsten wire is wound. Basically the electrodes are dipped into a mixture of thorium, calcium and barium carbonates.

They are heated to convert these compounds into oxides after dipping. Thus they get thermally and chemically stable to produce electrons. The electrodes are connected through a quartz tube by molybdenum foil leads.

Generally **mercury Vapour Lamp** operating power factor is 0.65, to improve the power factor, we connected a capacitor across the supply. And choke is used to develop a high voltage at the time of starting.

### Working of Mercury Vapour Lamp

Just when the main supply voltage is applied to the mercury lamp, this voltage comes across the starting electrode and the adjacent main electrode (bottom electrode) as well as across two main electrodes (bottom and top electrodes). As the gap between starting electrode and bottom main electrode is small the voltage gradient is high in this gap.

Because of this high voltage gradient across the stating electrode and the adjacent main electrode (bottom), a local argon arc is created, but the current gets limited by using a starting resistor.

This initial arc heats up the mercury and vaporizes it and this mercury vapour helps to strike the main arc soon. But the resistance for the main arc current control resistor is somewhat less than the resistance of the resistor used in the initial arc current control purpose. For this reason initial arc stops and main arc continues to operate. It takes 5 to 7 minutes to make all of the mercury to be vaporized completely. The lamp gets its state of its operational stability. The mercury vapor arc gives visible spectra of green, yellow and violet. But there may be still some invisible ultraviolet radiation during discharging process of **mercury vapour** so phosphor coating may be provided on outer glass cover to improve efficiency of the mercury lamp.

As the wattage increases the initial lumen ratings for the phosphor coated lamps get available with 4200, 8600, 12100, 22500 and 63000 ratings. The average life of mercury lamp is 24000 hours i.e. 2 years 8 months.

Mercury Lamp **data is given below.**

Watts	Bulb	Clear Lamp Initial Lumens	Initial Lamp Lumens/watt	Life in hour	Mean Lumen
100	E23 $\frac{1}{2}$	3850	38	24000	3120
175	E28	7950	43	24000	7470
250	E28	11200	45	24000	10300
400	E37	21000	52	24000	19100
1000	BT56	57000	57	24000	48400

### **Advantages**

The **advantages of the mercury vapor lamp** include the following.

- They are energy efficient (35 to 65 lumens/watts)
- Rated life of 24,000 hrs
- The output is clear white light
- It provides with high intensity
- It can be available in different colors, shapes, sizes, and ratings.

### **Disadvantages**

The disadvantages of the mercury vapor lamp include the following.

- Maintenance of lumen is poor
- It takes 5 to 7 minutes warmup before fully glowing the bulb
- The cooling time is 5 to 6 minutes
- They are voltage sensitive

### **Applications of Mercury Vapor Lamp**

The applications are

- Industrial areas
- Street lights
- [Security](#)
- Stairwells
- Home appliances like garages.

## **3.2.5 Sodium Vapour Lamps**

### **3.2.5a Low Pressure Sodium Vapour Lamp:**

A Low-Pressure Sodium Vapour lamp (or LPSV lamp) is termed as a “miscellaneous discharge lamp” as it possesses some characteristics of High-Intensity Discharge (HID) lamps as well as it resembles fluorescent lamps in other areas.

Low-Pressure Sodium Vapor lamp is invented first in **1920** by **Arther H Compton** at **Washington house, USA.**

Basically, an LPSV lamp is a gas discharge lamp that uses sodium in an excited state to produce light. A typical LPSV lamp is shown in the figure below.

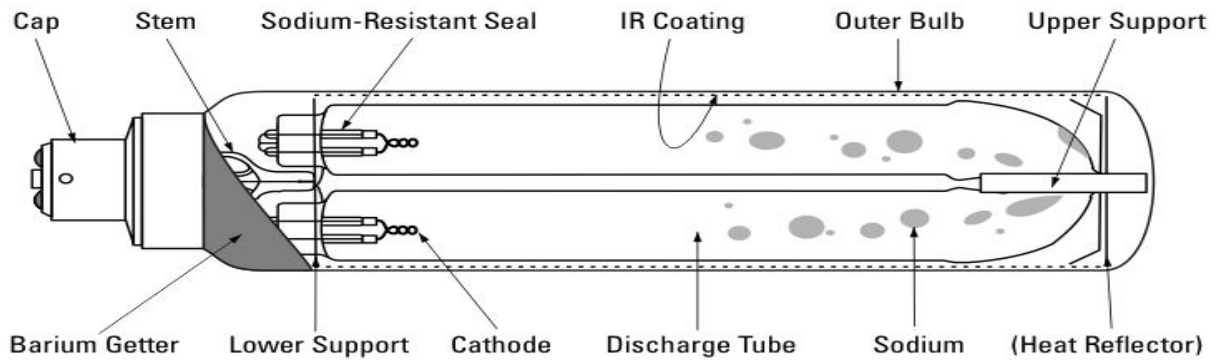

**The constructional features of the LPSV lamp are given below:**

1. The LPSV lamp contains two glass tubes one is outer glass tube (outer envelope) made up of borosilicate glass. The inner surface of the outer glass case is coated with indium oxide. This heat-reflective coating of indium oxide allows visible light to pass but reflects infra-red radiation back inside the tube as a result of which both light output and temperature inside the tube increases.
2. The arc tube of the LPSV lamp is made of glass and bent in the form of a U-shape in order to increase the length of the arc. The arc tube is supported at both ends. The arc tube contains a mixture of metallic sodium and inert gases argon and neon.
3. Neon gas serves to start discharge and to develop enough heat to vaporize sodium. Argon has lower growth, low voltage, argon helps the smaller start at a lower voltage.
4. Its operating power factor is 0.3, hence suitable capacitor must be used to improve the power factor.

**Operation of Low pressure Sodium vapour Lamp:**

Now we will discuss how an LPSV lamp actually operates. The basic operation of the LPSV lamp is similar to other gas discharge lamps in a sense that an arc is passed through a tube containing a metallic vapour. A starting gas is also required which is generally a mixture of inert gases argon and neon. The operation is explained step by step in details below:

1. When the lamp is not in operation the sodium is usually in the form of solid (metallic), deposited on the side walls of the tube
2. Electric power is given to the lamp and it is energized.
3. The electrodes produce an arc and this arc strikes through the conductive gas and the lamp produces a reddish-pink light, characteristic of neon.
4. Current flowing through the inert gas mixture of argon and neon generates heat.
5. This heat vaporises the metallic sodium.
6. With the passage of time, the quantity of sodium in the arc stream increases and this produces the characteristic monochromatic orange color at a wavelength of 489.6 nm.

For proper operation of LPSV lamp, typical pressure is about .005 torr and a temperature range between 250° to 270°

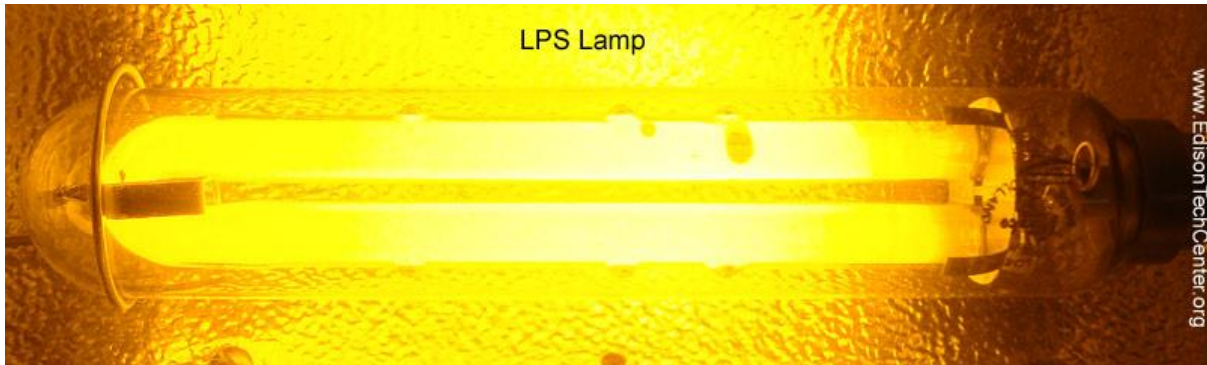

### Photometric Parameters

The [luminous efficacy](#) of the LPSV lamp is around 150-200 Lumens/Watt. Its **CRI** is very poor as it is monochromatic in nature. Its **CCT** is less than 2000K and the average life is around 18000 burning hours. LPSV lamps are not instant starting and take almost 5-10 minutes to come to full glow.

### Applications of LPSV Lamps

LPSV lamps are economical to use in road lighting and security lighting where the color of the object is not important. They are most suitable to use during foggy weathers

### 3.2.5b High Pressure Sodium Lamps or HPS Lamps

High-pressure sodium lamps (also known as HPS Lamps or HPS lights) are a type of sodium lamp that is widely used in industrial lighting and many public outdoor areas. They are commonly used in public parking lots, roadways, and other security areas.

A big driver behind their use is their high efficiency – around 100 lumens per Watt (when measured for photopic lighting conditions) Some higher-power lamps (>600 Watt) can achieve efficacies of around 150 lumens per watt.

It is very difficult to get any material which is free from corrosion in presence of sodium vapour in high temperature and pressure. This is the main difficulty of producing **high-pressure sodium lamp**.

In 1959, the development of polycrystalline alumina (PCA) or Lucalox (aluminium oxide ceramic) opened a new path to introduce the high-pressure sodium vapour Lamp, as this material is very rarely affected by high pressure and temperature sodium vapour. The first lamp with 400 W, 42000 initial lumens and 6000-hour life first came in the market in 1965. But afterward, some improvements made this lamp with 50000 initial lumens with 24000 hours at 10 hours per start. We can get a lamp that has 2.4 times the lumens output of its mercury counterpart with same rated life span.

## Construction High Pressure Sodium Lamp

### Diagram of High Pressure Sodium Lamp

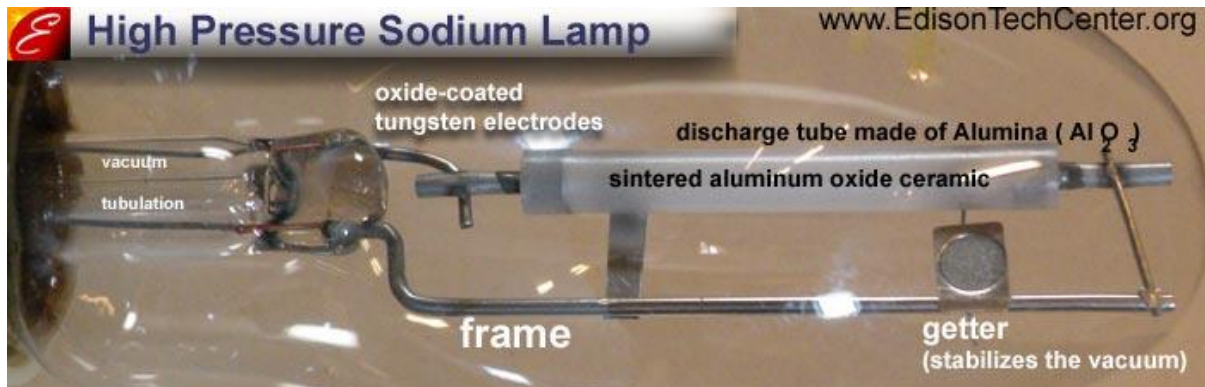

The HPS lamp consists of a narrow arc tube supported by a frame in a bulb. The arc tube has a high pressure inside for higher efficiency. It has an inner PCA arc tube that is filled with Sodium, mercury and xenon gas. This xenon gas is used for starting purpose of the lamp as ionization potential of xenon gas is lowest among all other inert gases used for this purpose. In each end, back wound and coated tungsten electrodes are mounted. To seal the tube monolithic seal is used instead of niobium end cap.

The arc tube is inserted into a heat resistant outer bulb. It is supported by an end clamp that is floating. This end clamp permits the entire structure to expand and contract without distorting.

The space between the tube and the bulb is a vacuum space. This vacuum space is needed to insulate heat from the arc tube because it is necessary to keep the arc tube at required temperature to sustain arc during normal operation. **High pressure sodium lamp** has very small diameter (3/8 inch). So there is no enough space to provide any starting electrode in the arc tube. So a higher voltage is required to initiate the [arc](#). A ballast with igniter is used for this purpose. High [voltage](#) is fed to the lamp from the ballast by using the phenomenon of superimposing a low energy high voltage pulse.

### Operation of High pressure sodium lamp

Generally a typical pulse has a peak voltage of 2500V and it has durability for only 1 microsecond only. This high voltage pulse makes the xenon gas ionized sufficiently. Then it initiates and maintains the xenon arc. The initial arc has sky blue color. Amalgam used in the reservoir formed inside the arc tube. It is in the back of one of the electrodes. It is normally vaporized during lamp operation. As the xenon arc has started temperature of arc tube is increased which first vaporizes mercury and the lamp start glowing with bluish white color. This color represents the effect of the xenon and mercury mixture at excitation. Gradually the temperature again rises, and sodium becomes vaporized lastly and becomes excited, a low pressure monochromatic yellow sodium spectrum results. During the period of sodium spectral line becomes at 589 nm. With temperature the sodium pressure increases from 0.02 atm in the monochromatic discharge to over 1 atm in the final steady state, broad spectrum condition. Also presence of excited mercury and xenon gives bluish effect to the lamp radiation and finally pleasant golden bright light comes out.



<b>Watts</b>	<b>Bulb</b>	<b>Clear Lamp initial Lumens</b>	<b>Initial Lamp lm/W</b>	<b>Life in hour</b>	<b>Mean Lumens</b>
100	E23 $\frac{1}{2}$	9500	95	24000	8500
150	E23 $\frac{1}{2}$	16000	106	24000	14400
150	E28	12000	80	12000	10800
215	E28	19000	88	12000	17100
250	E18	27500	110	24000	24750
360	E18	37000	103	16000	33300
400	E18	50000	125	24000	45000
1000	T18	140000	140	24000	126000

These lamps have high luminous efficacy and life span is about 24000 hours. It has excellent lumen maintenance capability. Data of several common **high pressure sodium lamps** are given below.

### 3.2.6 Metal Halide Lamps

#### What is Metal Halide Lamp?

*Metal halide lamp* is special type of arc discharge lamp that works on the arc stream via some iodide salts along with argon gas and mercury vapor pressure at several millimeters with the arc tube temperature of 1000 K.

Who Invented Metal Halide Lamp?

Dr. Reiling had discovered Metal Halide Lamp in 1960.

#### What is the Constructional Feature of a Metal Halide Lamp?

**Metal halide lamp** consists of

1. Glass bulb
2. Arc tube
3. Electrodes
4. Auxiliary electrode with high [resistance](#)
5. Glass stem
6. Molybdenum wire
7. Argon gas
8. Mercury vapor
9. Indium, thallium and sodium iodides

## Schematic Diagram of Metal Halide Lamp

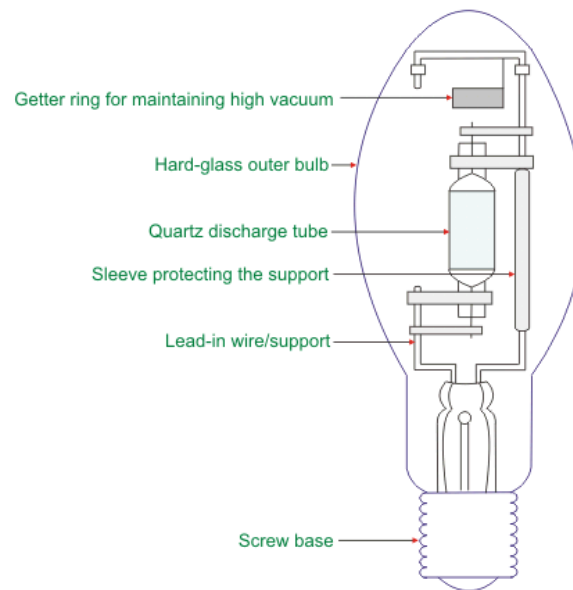

### How does a Metal Halide Lamp Work?

- When full [voltage](#) is applied across the main electrodes, no arc is produced at the time of switching.
- The auxiliary electrode or starter electrode near the main electrodes attached to the glass stem creates initial discharge between them.
- A bimetal switch is there to short the starter electrode to the main electrode just at the time of starting.
- Starter electrode is used to create initial [arc](#) between main and auxiliary electrode that heats up the metal halide salts.
- Starter electrode or auxiliary electrode is of high resistance to limit the current at initial arc.
- Again discharge is first in argon and then in mercury.
- Small amount of mercury vapor helps to establish main arc formation between main electrodes through metal halides vapor one by one.
- To reach up to full light output this lamp takes 5 minutes.

### How arc Inside the Metal Halide Arc Tube is Established?

In the OFF condition of the lamp, metal iodides i.e. indium, thallium and sodium iodides used inside the lamp are present on the bulb wall.

Due to rising of arc temperature, the metal iodides vaporize and diffuse from wall into the arc stream. Then they dissociate and yield free metal and iodine atoms. Almost like this fashion, the mercury atoms inside the bulb are excited and ionized. Generally all iodide salts do not get vaporized at same time in **metal halide lamp**. So step wise, the process of vaporization is

- First argon gas and then mercury get vaporized to form arc.
- Only indium gets vaporized first to form a blue sheath around the mercury arc.



- Then thallium gets vaporized and it forms yellow sheath around the thallium.
- Finally sodium iodides get vaporized and it makes the lamp very sensitive to changes in the lamp wattage.

Lamp will be deficient in yellow and red if the lamp watts are lower than rated value. It is because of very small amount of sodium gets vaporized. Again in case of sodium-scandium **metal halide lamps**, scandium vaporizes first and then sodium.

What are the Basic Requirements of Metal Halides Inside the Arc Tube?

The basic requirements of the metal additive are mentioned below:

1. The iodide vapor pressure must be relatively high enough.
2. The energy level configuration of the metal must be robust to encourage a high percentage of the visible radiation.
3. At the bulb wall operating temperature of the iodide of the metal must be stable.
4. The excitation level of the metal atoms must be lower than the average of the excitation level of mercury (about 7.8 eV).

Thallium has a strong spectral line at 535 nm and it requires only 3.3 eV for its arc generation. Its iodide salt creates vapor pressure at about 10 mm at 800 K on the arc tube.

Why Metal Halide Lamp is with Frameless Construction?

This lamp has frameless construction. Molybdenum is used as outer electric wire and it is non magnetic. The reason is ac current would flow through the frame and create pulsating [magnetic field](#). So this would cause the electron to leave the frame and would attract to combine with the sodium ions which would migrate through the arc tube wall. It would cause serious depletion of the sodium from the arc stream.

Why is there Reflective Coating at both ends of Metal Halide Arc Tube?

The **metal halide lamp** has an arc tube whose ends are taken to be treated with a reflective white coating that is used to redirect the energy back into the tube. A uniform temperature can be maintained over entire arc tube length due to short length.

**What are the Ratings of Metal Halide Lamp Available in the Market?**

Watts	Bulb	Clear Lamp Initial Lumen	Initial Lamp lm/W	Life in hours	Mean Lumen
175	BT28	14000	80	7500	10800
250	BT28	20500	82	7500	17000
400	B37	34000	85	15000	20400
1000	BT56	115000	115	10000	92000
1500	BT56	155000	103	1500	14000

### 3.2.7 Light Emitting Diode LED Lamp

#### What is a Light Emitting Diode (LED)?

A **light-emitting diode (LED)** is a semiconductor light source that emits light when current flows through it. Electrons in the semiconductor recombine with electron holes, releasing energy in the form of photons. The color of the light (corresponding to the energy of the photons) is determined by the energy required for electrons to cross the band gap of the semiconductor.

A Light Emitting Diode (LED) is a special type of PN junction diode. The light emitting diode is specially doped and made of a special type of semiconductor. This diode can emit light when it is in the forward biased state. Aluminum indium gallium phosphide (AlInGaP) and indium gallium nitride (InGaN) are two of the most commonly used semiconductors for LED technologies.

Older LED technologies used gallium arsenide phosphide (GaAsP), gallium phosphide (GaP), and aluminum gallium arsenide (AlGaAs). LEDs generate visible radiation by electroluminescence phenomenon when a low-voltage direct current is applied to a suitably doped crystal containing a p-n junction, as shown in the diagram below.

The doping is typically carried out with elements from column III and V of the periodic table. When a forward biased current,  $I_F$ , energizes the p-n junction, it emits light at a wavelength defined by the active region energy gap,  $E_g$ .

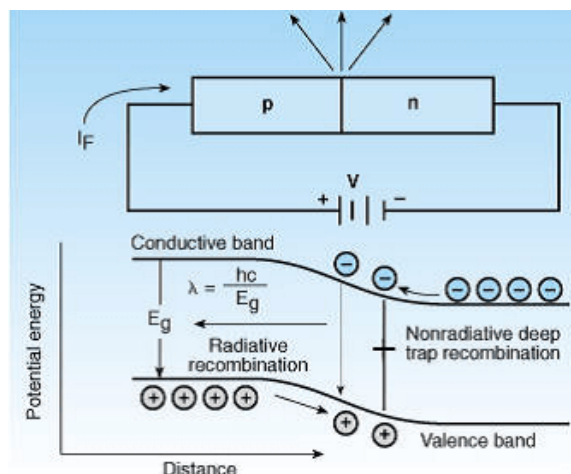

#### Construction of LED

The recombination of the charge carrier occurs in the P-type material, and hence P-material is the surface of the LED. For the maximum emission of light, the anode is deposited at the edge of the P-type material. The cathode is made of gold film, and it is usually placed at the bottom of the N-region. This gold layer of cathode helps in reflecting the light to the surface.

The gallium arsenide phosphide is used for the manufacturing of LED which emits red or yellow light for emission. The LED are also available in green, yellow amber and red in colour.

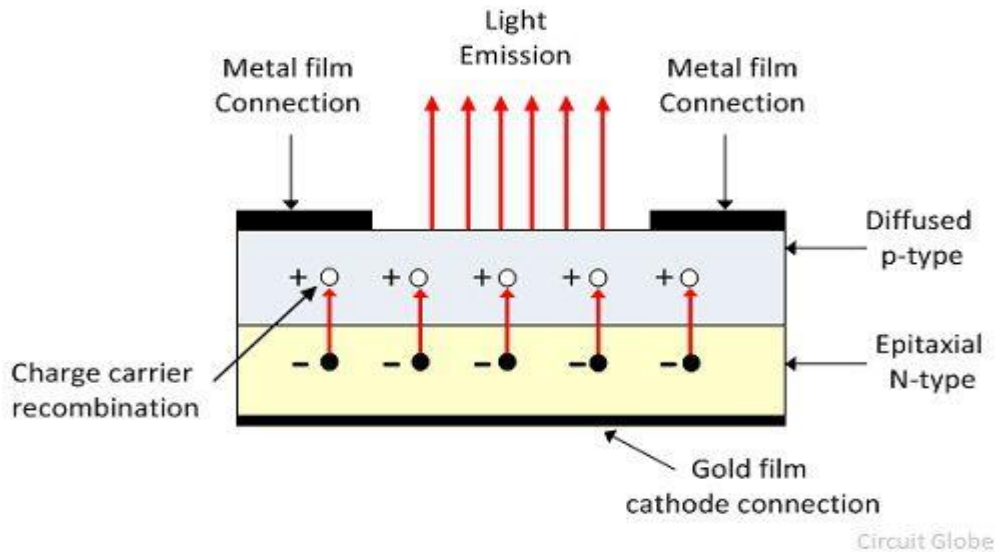

### How Does a Light Emitting Diode (LED) Work?

- Light Emitting Diode (LED) works only in forward bias condition. When Light Emitting Diode (LED) is forward biased, the free electrons from n-side and the holes from p-side are pushed towards the junction.
- When free electrons reach the junction or depletion region, some of the free electrons recombine with the holes in the positive ions. We know that positive ions have less number of electrons than protons. Therefore, they are ready to accept electrons. Thus, free electrons recombine with holes in the depletion region. In the similar way, holes from p-side recombine with electrons in the depletion region.
- Because of the recombination of free electrons and holes in the depletion region, the width of depletion region decreases. As a result, more charge carriers will cross the p-n junction.

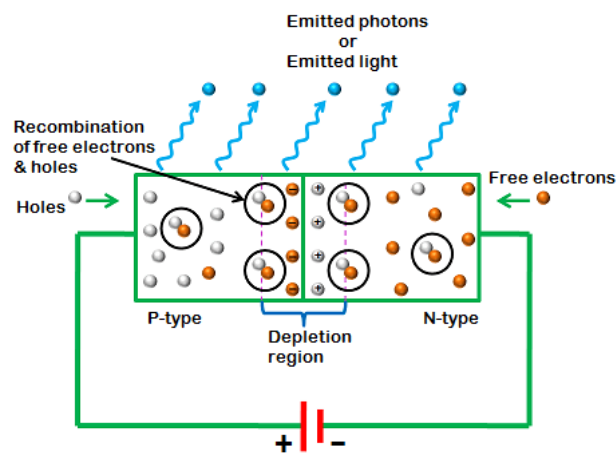

**Light Emitting Diode (LED)**

- Some of the charge carriers from p-side and n-side will cross the p-n junction before they recombine in the depletion region. For example, some free electrons from n-type semiconductor cross the p-n junction and recombines with holes in p-type semiconductor. In the similar way, holes from p-type semiconductor cross the p-n junction and recombines with free electrons in the n-type semiconductor.
- Thus, recombination takes place in depletion region as well as in p-type and n-type semiconductor.  
The free electrons in the conduction band releases energy in the form of light before they recombine with holes in the valence band. In silicon and germanium diodes, most of the energy is released in the form of heat and emitted light is too small.
- However, in materials like gallium arsenide and gallium phosphide the emitted photons have sufficient energy to produce intense visible light.

	AlInGaP	InGaN
Energy gap ( $E_g$ )	1.8–2.31 eV	3.4 eV (blue)
Peak wavelength ( $\lambda$ )	585 nm (amber)	460 nm (blue) 520 nm (green)
Luminous efficacy (external)	20–25 lm/W (amber)	6 lm/W (blue) 30 lm/W (green)

The efficacy depends on the light energy generated at the junction and losses due to re-absorption when light tries to escape through the crystal. The high index of refraction of most semiconductors causes the light to reflect back from the surface into the crystal and highly attenuated before finally exiting. The efficacy expressed in terms of this ultimate measurable visible energy is called the external efficacy.

The phenomenon of electroluminescence was observed in the year 1923 in naturally occurring junctions, but it was impractical at that time due to its low luminous efficacy in converting electric energy to light. But, today efficacy has increased considerably and LEDs are used not only in signals, indicators, signs, and displays but also in indoor lighting applications and road lighting applications.

## VI Characteristics and Symbol of LED

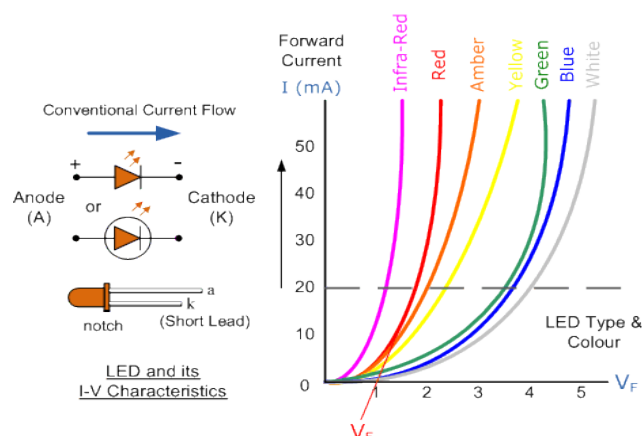

## Types of Light Emitting Diode

- Gallium Arsenide (GaAs) – infra-red
- Gallium Arsenide Phosphide (GaAsP) – red to infra-red, orange
- Aluminium Gallium Arsenide Phosphide (AlGaAsP) – high-brightness red, orange-red, orange, and yellow
- Gallium Phosphide (GaP) – red, yellow and green
- Aluminium Gallium Phosphide (AlGaP) – green
- Gallium Nitride (GaN) – green, emerald green
- Gallium Indium Nitride (GaInN) – near ultraviolet, bluish-green and blue
- Silicon Carbide (SiC) – blue as a substrate
- Zinc Selenide (ZnSe) – blue
- Aluminium Gallium Nitride (AlGaN) – ultraviolet

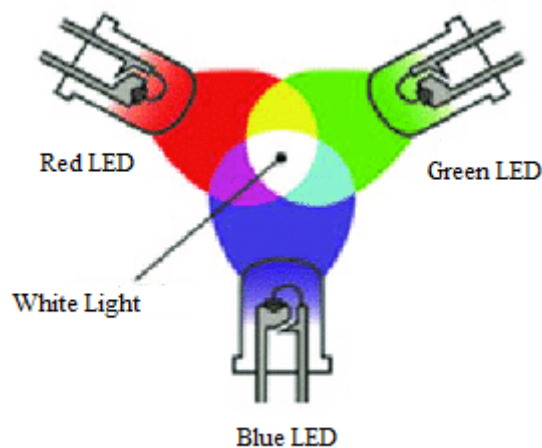

## Color of an LED

The color of an LED device is expressed in terms of the dominant wavelength emitted,  $\lambda_d$  (in nm). AlInGaP LEDs produce the colors red (626 to 630 nm), red-orange (615 to 621 nm), orange (605 nm), and amber (590 to 592 nm). InGaN LEDs produce the colors green (525 nm), blue green (498 to 505 nm), and blue (470 nm). The color and forward voltage of AlInGaP LEDs depend on the temperature of the LED p-n junction.

As the temperature of the LED p-n junction increases, the luminous intensity decreases, the dominant wavelength shifts towards longer wavelengths, and the forward voltage drops. The variation in luminous intensity of InGaN LEDs with operating ambient temperature is small (about 10%) from  $-20^{\circ}\text{C}$  to  $80^{\circ}\text{C}$ . However, the dominant wavelength of InGaN LEDs does vary with LED drive current; as the LED drive current increases, dominant wavelength moves toward shorter wavelengths.

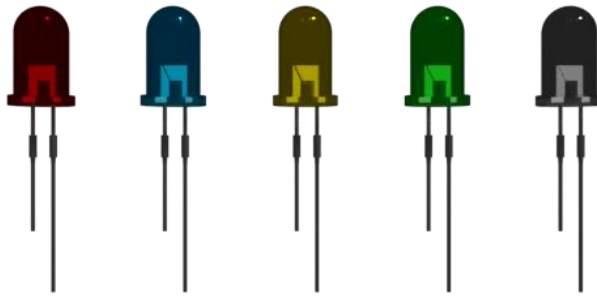

If you're looking to use colored LEDs for an electronics project, the [best Arduino starter kits](#) include a variety of colored LEDs.

### Dimming

LEDs may be dimmed to give 10% of their rated light output by reducing the drive current. LEDs are generally dimmed using Pulse Width Modulation techniques.

### Reliability

The rated maximum junction temperature ( $T_{JMAX}$ ) is the most critical parameter for an LED. Temperatures exceeding this value usually result in damage of the plastic encapsulated LED device. Mean Time Between Failures (MTBF) is used to find out the average life for LED. MTBF is determined by operating a quantity of LED devices at rated current in an ambient temperature of  $55^{\circ}\text{C}$  and recording when half the devices fail.

### White LEDs

White LEDs are being manufactured now using two methods: In the first method red, green, and blue LED chips are combined in the same package to produce white light; In the second method phosphorescence is used. Fluorescence in the phosphor that is encapsulated in the epoxy surrounding the LED chip is activated by the short-wavelength energy from the InGaN LED device.

### Luminous Efficacy

Luminous efficacy of LED is defined as the emitted luminous flux (in lm) per unit electrical power consumed (in W). Blue LEDs have a rated internal efficacy in the order of 75 lm/W; red LEDs, approximately 155 lm/W; and amber LEDs, 500 lm/W. Taking into consideration losses due to internal re-absorption, the luminous efficacy is on the order of 20 to 25 lm/W for amber and green LEDs. This definition of efficacy is called external efficacy and is analogous to the definition of efficacy typically used for other light source types.

### Applications of LEDs

- Electronic displays such as OLEDs, micro-LEDs, quantum dots etc.
- As an LED indicator.
- In remote controls.

- Lightings.
- Opto-isolators.

### Advantages of LED in electronic displays

The followings are the major advantages of the LED in an electronics displays.

1. The LED are smaller in sizes, and they can be stacked together to form numeric and alphanumeric display in the high-density matrix.
2. The intensity of the light output of the LED depends on the current flows through it. The intensity of their light can be controlled smoothly.
3. The LED are available which emits light in the different colours like red, yellow, green and amber.
4. The on and off time or switching time of the LED is less than of 1 nanoseconds. Because of this, the LED are used for the dynamic operation.
5. The LEDs are very economical and giving the high degree of reliability because they are manufactured with the same technology as that of the transistor.
6. The LED are operated over a wide range of temperature say  $0^{\circ} - 70^{\circ}$ . Also, it is very durable and can withstand shock and variation.
7. The LED have a high efficiency, but they require moderate power for operation. Typically, the voltage of 1.2V and the current of 20mA is required for full brightness. Therefore, it is used in a place where less power are available.

### Disadvantages of LED

The LED consume more power as compared to LCD, and their cost is high. Also, it is not used for making the large display.

### 3.3 Luminous Performance Characteristics of commonly used Luminaries

Table Luminous Performance Characteristics of Commonly Used Luminaries					
Type of Lamp	Lumens / Watt		Colour Rendering Index	Typical Application	Typical Life (hours)
	Range	Avg.			
Incandescent	8-18	14	Excellent (100)	Homes, restaurants, general lighting, emergency lighting	1000
Fluorescent lamps	46-60	50	Good w.r.t. coating (67-77)	Offices, shops, hospitals, homes	5000
Compact fluorescent lamps (CFL)	40-70	60	Very good (85)	Hotels, shops, homes, offices	8000-10000
High pressure mercury (HPMV)	44-57	50	Fair (45)	General lighting in factories, garages, car parking, flood lighting	5000



Halogen lamps	18-24	20	Excellent (100)	Display, flood lighting, stadium exhibition grounds, construction areas	2000-4000
High pressure sodium (HPSV) SON	67-121	90	Fair (22)	General lighting in factories, warehouses, street lighting	6000-12000
Low pressure sodium (LPSV) SOX	101-175	150	Poor (10)	Roadways, tunnels, canals, street lighting	6000-12000
Metal halide lamps	75-125	100	Good (70)	Industrial bays, spot lighting, flood lighting, retail stores	8000
LED lamps	30-50	40	Good (70)	Reading lights, desk lamps, night lights, spotlights, security lights, signage lighting, etc.	40,000-1,00,000

### 3.4 Recommended Illuminance Levels for Various Tasks / Activities / Locations:

#### Recommendations on Illuminance

**Scale of Illuminance:** The minimum illuminance for all non-working interiors, has been mentioned as 20 Lux (as per IS 3646). A factor of approximately 1.5 represents the smallest significant difference in subjective effect of illuminance. Therefore, the following scale of illuminances is recommended.

20–30–50–75–100–150–200–300–500–750–1000–1500–2000, ... Lux

**Illuminance ranges:** Because circumstances may be significantly different for different interiors used for the same application or for different conditions for the same kind of activity, a range of illuminances is recommended for each type of interior or activity intended of a single value of illuminance. Each range consists of three successive steps of the recommended scale of illuminances. For working interiors the middle value (R) of each range represents the recommended service illuminance that would be used unless one or more of the factors mentioned below apply.

The higher value (H) of the range should be used at exceptional cases where low reflectances or contrasts are present in the task, errors are costly to rectify, visual work is critical, accuracy or higher productivity is of great importance and the visual capacity of the worker makes it necessary.

Similarly, lower value (L) of the range may be used when reflectances or contrasts are unusually high, speed and accuracy is not important and the task is executed only occasionally.

#### Recommended Illumination

The following Table gives the recommended illuminance range for different tasks and activities for chemical sector. The values are related to the visual requirements of the task, to user's



satisfaction, to practical experience and to the need for cost effective use of energy.(Source IS 3646 (Part I) : 1992).

*For recommended illumination in other sectors, reader may refer Illuminating Engineers Society Recommendations Handbook/*

<b>Petroleum, Chemical and Petrochemical works</b>	
Exterior walkways, platforms, stairs and ladders	30-50-100
Exterior pump and valve areas	50-100-150
Pump and compressor houses	100-150-200
Process plant with remote control	30-50-100
Process plant requiring occasional manual intervention	50-100-150
Permanently occupied work stations in process plant	150-200-300
Control rooms for process plant	200-300-500
<b>Pharmaceuticals Manufacturer and Fine chemicals manufacturer</b>	
<b>Pharmaceutical manufacturer</b>	
Grinding, granulating, mixing, drying, tableting, sterilising, washing, preparation of solutions, filling, capping, wrapping, hardening	300-500-750
<b>Fine chemical manufacturers</b>	
Exterior walkways, platforms, stairs and ladders	30-50-100
Process plant	50-100-150
Fine chemical finishing	300-500-750
Inspection	300-500-750
Soap manufacture	
General area	200-300-500
Automatic processes	100-200-300
Control panels	200-300-500
Machines	200-300-500
<b>Paint works</b>	
General	200-300-500
Automatic processes	150-200-300
Control panels	200-300-500
Special batch mixing	500-750-1000
Colour matching	750-100-1500

### 3.5 lighting equipment's:

#### 3.5.1 Control gear

A wide range of lamps require control gear of some kind to ensure correct running and, in some cases, starting of the lamp. With discharge lamps it is the job of the control gear to limit the current through the lamp whereas with some incandescent lamps the gear is there to reduce the voltage. Some low voltage tungsten lamps need units to supply them with the correct voltage and LEDs need electronics to limit the current going through them.

##### 3.5.1.1 Ballasts for discharge light sources

###### General principles

**Control gear for discharge lamps has to perform a number of functions:**

- limit and stabilises lamp current: due to the negative resistance characteristic of gas discharge lamps (see Section 3.1.2) it is necessary to control the current in the lamp circuit
- ensure that the lamp continues to operate despite the mains voltage falling to zero at the end of each half cycle
- provide the correct condition for the ignition of the lamp: this generally requires the gear to provide a high voltage and in the case of fluorescent lamps requires a heating current to be passed through the electrodes.

As well as these basic functions control gear may also have the following requirements placed on it:

- ensure a high power factor
- limit the harmonic distortion in the mains current
- limit any electromagnetic interference (EMI) produced by the lamp and ballast
- limit the short-circuit and run up currents to protect the lamp electrodes and to help the supply wiring system
- keep the lamp current and voltage within the specified limits for the lamp during mains voltage fluctuations.

With electromagnetic control gear several separate control components may be needed — these may include ballasts, starters, igniters, capacitors and filter-coils.

When electronic control gear is used it is common to integrate all the components into one package. The details of the various circuits used are discussed in the following sections.

### Electromagnetic control gear for fluorescent light sources

Choke coils used to be the most common type of current limiting device used with linear and compact fluorescent lamps. The most common circuit is the switch start, see Figure 5.1.

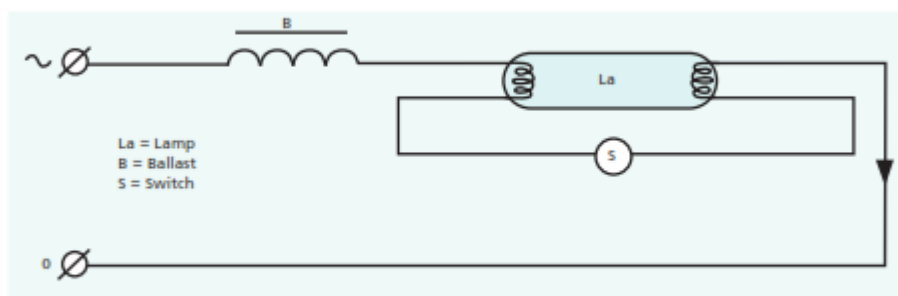

**Figure 5.1** Schematic diagram of a fluorescent lamp operated using a choke ballast and a switch start

The choke ballast is made from a large number of windings of copper on a laminated iron core. It works on the self-inductance principle and is designed so that impedance of the choke limits the current through the circuit to the correct value for a given lamp and supply voltages. A range of ballasts is available for different lamps and different voltages. Also the ballast design has to be changed if it is to operate at a different mains supply frequency.

To start the lamp it is common to use a glow starter. The glow starter switch consists of one or two bi-metallic strips enclosed in a glass tube containing a noble gas. The glow starter is connected across the lamp so it is possible for a current to pass through the ballast, through the electrode at one end of the lamp, through the electrode at the other end of the lamp and back to neutral.

When the mains voltage is first applied to the lamp circuit, the total mains voltage appears across the electrodes of the starter and this initiates a glow discharge. This discharge heats the bi-metallic elements within the starter and as the electrodes heat up they bend towards each other until eventually they touch. While the electrodes are touching the current passing through the lamp electrodes pre-heats them. While the electrodes in the starter are touching there is no glow discharge and so the electrodes cool and separate. At the moment that the electrodes come apart the current through the ballast is interrupted causing a voltage peak across the lamp. *Note:* the glow starter does not always create the conditions for the lamp to start and sometimes the starting cycle has to be repeated a number of times. Figures 5.2 to 5.4 illustrate the starting process.

**Figure 5.2** The heat from the discharge in the starter causes the bi-metallic electrodes to bend together

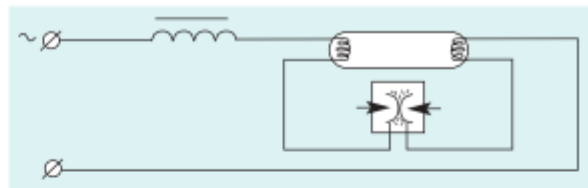

**Figure 5.3** The bi-metallic electrodes touch and a current flows through the circuit preheating the electrodes of the lamp

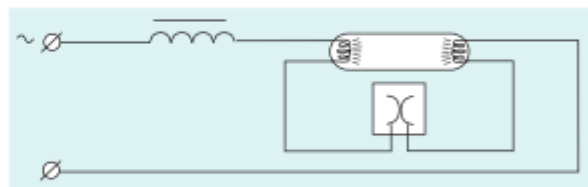

**Figure 5.4** The electrodes cool and separate, causing a voltage peak which ignites the lamp

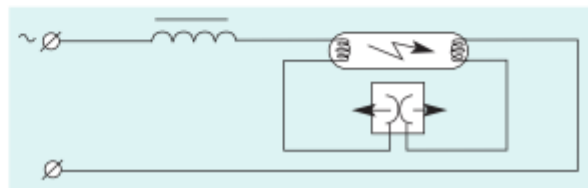

In addition to the ballast and the starter most fluorescent lamps circuits have a capacitor connected across the supply terminals to ensure a high power factor for the circuit.

### Electromagnetic control gear for HID light sources

There are a number of different types of circuits used for high intensity discharge (HID) lamps; they vary according to the type of lamp and its requirements for starting.

The most common type of ballast used is a choke or inductive ballast in series with the lamp. The choke, which is a coil of copper wire wound on a laminated iron core, limits the current through the lamp. Figure 5.5 shows a typical circuit using a choke.

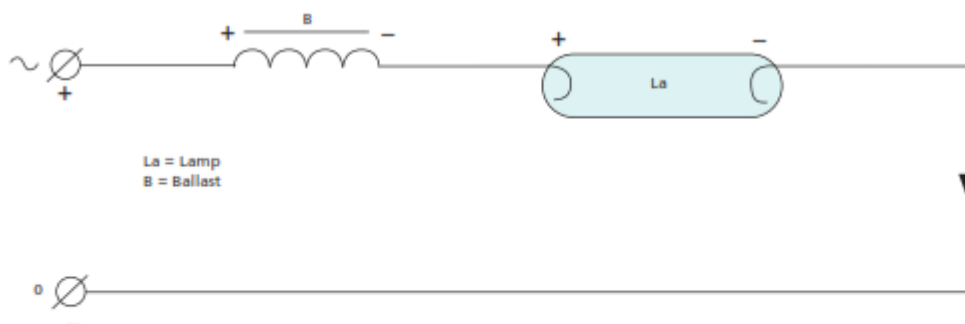

**Figure 5.5** Schematic diagram of a HID lamp circuit using a choke

This type of circuit is used for all high intensity discharge lamps apart from the low pressure sodium lamp. The low pressure sodium lamp has a long run-up during which time the voltage across the lamp needs to be greater than normal mains voltage; this has given rise to a number of circuits for running the lamp that provide the necessary voltage. The most common of these circuits is the autoleak transformer (Figure 5.6).

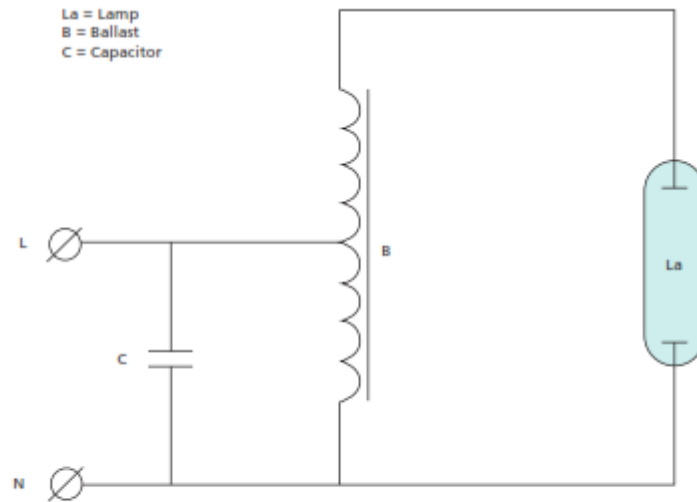

**Figure 5.6** Schematic diagram of a low pressure sodium lamp circuit using an autoleak transformer

The autoleak transformer works like an autotransformer increasing the supply voltage, but by careful design of the secondary winding it can also act as a choke to control the current through the lamp.

Most high pressure sodium lamps and metal halide lamps require a high voltage pulse to start the arc in the lamp. This is usually provided by an electronic ignitor. There are several types of ignitor circuits, the two most common are the semi-parallel and the superimposed pulse type (Figures 5.7 and 5.8).

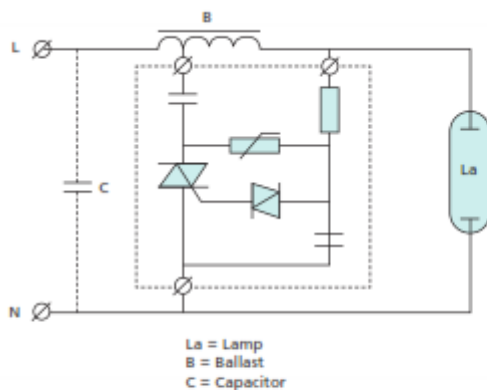

**Figure 5.7**  
A semi-parallel ignition system

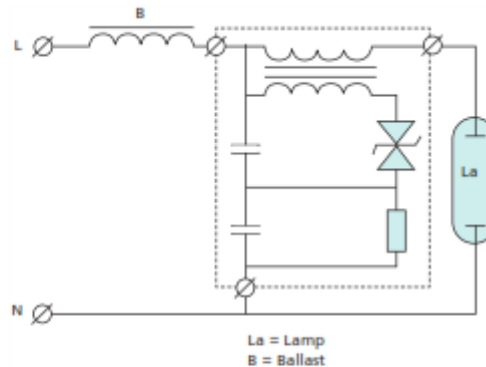

**Figure 5.8**  
A superimposed ignition system

The semi-parallel ignitor relies on the tapped ballast coil to generate the ignition pulse whereas the superimposed type ignitor has its own coil to generate the pulse. The semi-parallel has many advantages in that it consumes no power when the lamp is running, it is cheaper and

lighter but, as it relies on the ballast, it may only be used with the ballast for which it has been specifically designed.

Ignitors sometimes have other features built in such as self-stopping ignitors that will not continually try to restrike a lamp that has come to the end of its life. There are also some that are designed to produce extra high voltages that can restrike hot lamps.

### Electronic control gear for fluorescent light sources

Operating fluorescent lamps at high frequency has a number of advantages and most modern control gear is now of this type. Most electronic ballasts for fluorescent lamps are integrated into a single package that performs a number of functions.

These functions are:

- a low pass filter: this limits the amount of harmonic distortion caused by the ballast, controls the amount of radio frequency interference, protects the ballast against high voltage mains peaks and limits the inrush current
- the rectifier: this converts the AC power from the mains supply into DC
- a buffer capacitor: this stores the charge from each mains cycle thus providing a steady voltage to the circuits that provide the power to the lamps
- the HF power oscillator takes the steady DC voltage from the buffer capacitor and using semiconductor switches controlled by the ballast controller creates a high frequency square wave
- the output of the power oscillator is fed through a small HF coil that acts as a stabilisation coil to the lamp.

Figure 5.9 shows the main components in typical HF fluorescent lamp ballast

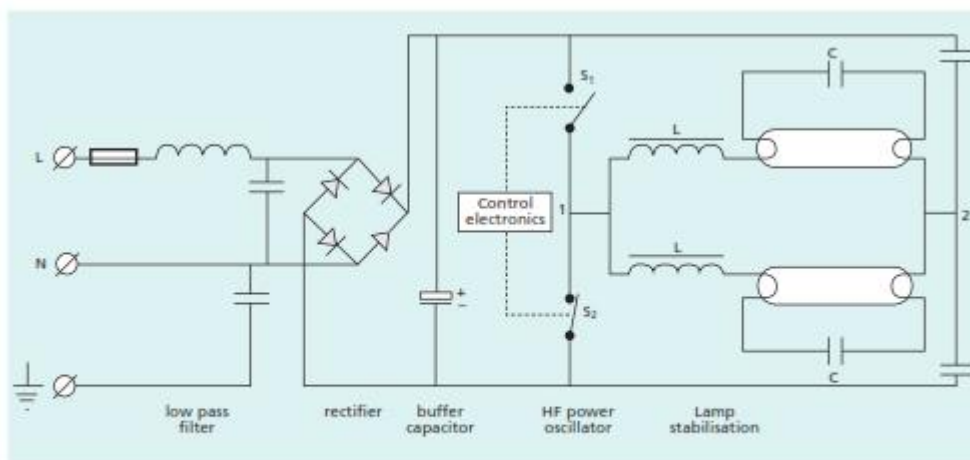

**Figure 5.9** A circuit diagram of an electronic ballast for two fluorescent lamps

In some ballasts the electronics that control the power oscillator can vary the frequency at which the power oscillator runs; as the frequency increases the current passing through the coils decreases and thus it is possible to dim the lamps. Some types of ballast have a 0 to 10 volt input that is used to regulate the output while some have digital interfaces. See Section 5.2 for further information on controls.

### Electronic gear for HID light sources

Making electronic control gear for HID light sources is a complex process. There are many different lamp types each with different electrical requirements and a limited range of

frequencies in which they can be operated. Also many lamp types do not show a significant gain in efficiency when operated on high frequencies. For these reasons electronic control gear has been developed more slowly for HID lamps than for fluorescent lamps.

However, it is possible to gain a number of benefits from electronic gear for HID lamps.

These include:

- increased lamp life
- elimination of visible flicker
- better system efficacy
- less sensitivity to mains voltage or temperature fluctuations
- the possibility of dimming with some lamp types.

Not all these benefits are possible for all lamp types and all control gear combinations. However, the availability and quality of electronic gear available for HID lamps is rapidly increasing.

### 3.5.1.2 Transformers for low voltage light sources

Many tungsten halogen lamps are designed to run on low voltages the most common of which is 12 volts. Thus they need a device to reduce the supply voltage. The traditional way to do this was by using a transformer. Figure 5.10 shows the various currents and voltages in a transformer and gives the approximate relationship between the voltages, currents and the number of turns in the primary and secondary coils.

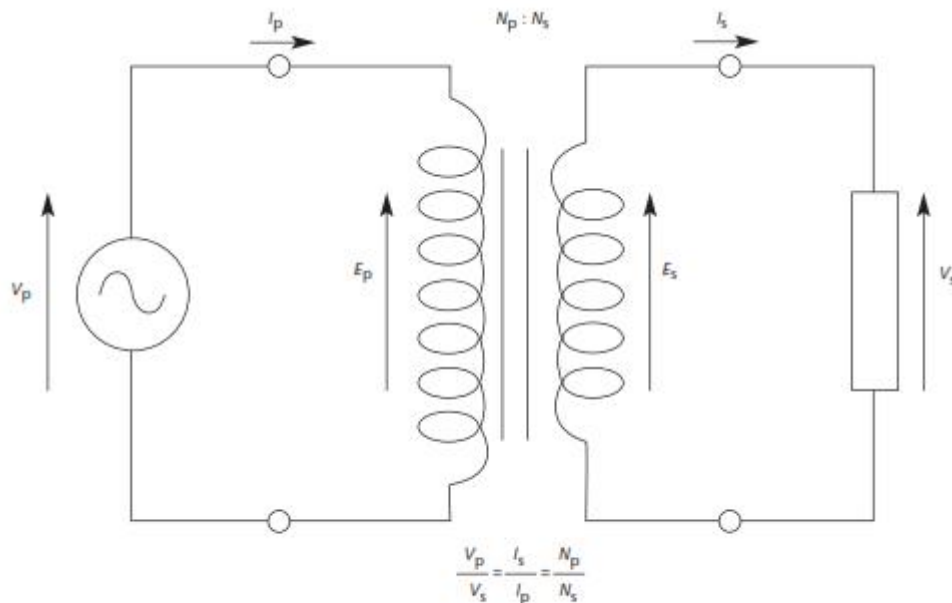

**Figure 5.10** A circuit diagram for a transformer

As well as reducing the voltage the transformer also isolates the lamp supply from the mains. This means that even under a fault condition the voltage in the secondary circuit will not rise significantly above the nominal output voltage and so it will always be safe to touch the conductors on the low voltage side.

Most modern transformers for halogen lamps involve electronics. They usually contain high frequency oscillators to permit the use of smaller transformers that have smaller power losses. With the introduction of electronics it is possible to introduce additional features such as constant voltage output and soft starting of the lamps.

### 3.5.1.3 Drivers for LEDs

LEDs need to be run at a controlled current to ensure proper operation. To provide this drivers re used. Most drivers take mains power and provide a constant current output. However, it is possible to control some drivers so that output current is varied so that the LED may be dimmed. In more complex systems it is possible to dim three separate channels separately, so that when red, green and blue LEDs are used together it is possible to make colour changes. Most LED drivers can maintain their constant current output over a range of voltages so it is often possible to connect a number of LEDs in series on one driver.

### 3.5.2 Lighting controls

#### 3.5.2.1 Options for control

There are a number of factors that need to be considered in any control system; these are the inputs to system, how the system controls the lighting equipment and what is the control process that decides how a particular set of inputs will impact on the lighting. Thus for a control system to work it must have:

- **input devices:** such as switches, presence detectors, timers and photocells
- **control processes:** these may consist of a simple wiring network through to a computer based control system
- **Controlled luminaires:** the system may control luminaires in a number of ways, from simply switching them on and off to dimming the lamp and in more complex systems causing movement and colour changes.

#### 3.5.2.2 Input devices

##### Manual inputs

These vary from simple switches used to turn the lights on though dimmer switches and remote control units that interface to a control system to lighting control desks that are used in theatres. The point of these units is to allow people to control the lighting and care is always needed in the application of such devices to ensure that users of the system can readily understand the function of any such control.

##### Presence detectors

Most presence detectors are based on passive infrared (PIR) detectors, however some devices are based on microwave or ultrasonic technology. PIR devices monitor changes in the amount of infrared radiation that they are receiving. The movement of people in a space will be detected by them and this can be signalled to a control system. Thus, if a device detects the presence of a person this can be used to signal the control system to switch the lights on, but if the device has not detected anybody for some time this can be used to signal that there is nobody there and that the lights can be turned off.

##### Timers

Most computerised control systems have timers built in so that they can turn the lighting on or off at particular times. However, there are also a large number of time switches available that can turn lamps on an off at given times. There are also timers used in street lighting that change the time that they switch at throughout the year so that the lamps are switched at dawn and dusk.

## Photocells

There are many different types of photocell used to control lighting. The simplest to use are those which switch on at one illuminance value and switch off at another; these are commonly used to turn exterior lights on at dusk and off at dawn. Some photocells communicate the illuminance value to the central control system, which uses the information to adjust the lighting in some way. Some photocells are mounted on ceilings with shields around them so that they only receive light reflected from the working plane, this makes them act like luminance meters and provided the reflectance of the working plane remains constant they can be set up to follow the illuminance of that plane.

### 3.5.2.3 Control processes and systems

In the case of simple control systems these are generally configured as some form of automated switching in the power supply to a luminaire or group of luminaires. However, more complex systems are generally configured as a network of devices including luminaires, sensors and control inputs. In most systems the devices are physically connected using some form of cabled network but, in principle, devices can be controlled using wireless or infrared communication.

There are several systems in common use for lighting systems and care needs to be taken to specify the correct type for each component in the system. Two of the most common systems available are DALI and DMX 512.

The basic specification for DALI systems is contained in BS EN 60929: 2006: *AC-supplied electronic ballasts for tubular fluorescent lamps — Performance requirements*. The DALI system is largely used for lighting systems in buildings but has been extended so that it can be used more widely.

It controls luminaires via the ballast used to control the lamps. The system is designed to run up to 64 luminaires on one circuit but there are devices that can control a series of different DALI clusters thus making it possible to control all the lights in a large building.

DMX 512 was designed to control lights and other equipment in the entertainment industry. The system provides 512 channels of control to a series of devices. In a typical spotlight that has its aiming controlled, three channels may be used, one to dim the luminaire and one for each axis of rotation. The system has traditionally been used in theatres but is increasingly being used in architectural feature lighting where the lighting equipment is more complex. The basic operating properties of the system are described in ANSI E1.11: *USITT DMX512-A: Asynchronous serial digital data transmission standard for controlling lighting equipment and accessories*.

## 3.6 Determine the method of lighting, and calculate the lighting parameters.

- Design Considerations
- Typical Calculations
  - Watts/sq.m method
  - Lumen Method
  - Point-by-point Method
- Other Calculations
- Outdoor Lighting



### 3.6.1 Design Considerations

- **Basic lighting calculations that are required to carry out a lighting design**
  - Luminous flux, luminous intensity, illuminance, luminance, colour rendering, colour temperature
  - Glare, working plane, surface reflectances
  - Indoor lighting: calculations are done for both the direct and inter-reflected light; room geometry; maintenance
  - Outdoor lighting: light falls directly on the working plane
- **Lighting design checklist**
  - Safety (e.g. emergency escape lighting)
  - Task requirements
  - Lighting scheme to provide suitable quantity and direction for the task; colour rendering; glare problems
  - Lighting appearance
  - Architecture/Interior design
  - Energy efficiency
  - Lighting equipment, controls, daylighting
- **Lighting equipment checklist**
  - Lamps
  - Operating characteristics, lamp size/shape, colour
  - Luminaires
    - Size and shape, light distribution, glare control, ballast
  - Operating environment (e.g. corrosive, dusty)
  - Lighting controls
    - Manual switches, time switches, dimming, daylightlinked controls, occupant sensing
- **Collect information for lighting design**
  - **Room details:**
    - Room size (length, width, height)
    - Horizontal working plane height above floor level
    - Room surface reflectance (ceiling, walls, and floor)
    - Window size/s and position
    - Room index
      - $$K = (L \times W)/(L + W) H$$
  - Cleanliness of the room/environment
  - The regularity of the cleaning

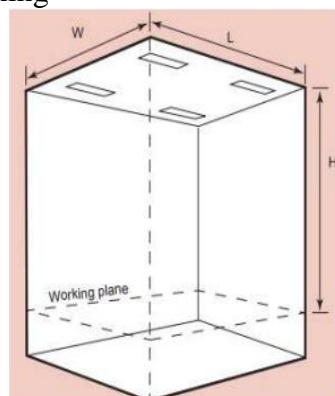

- **Task details:**
  - Type of task/application (e.g. office, industrial, retail)

- Task position (e.g. horizontal/vertical, general/local)
  - Special task lighting requirement (e.g. critical inspection, computer use, disabled persons)
  - Special hazards (e.g. wet or dusty environment, rotating machines) --- luminaire thermal and mechanical protection
- **Task lighting requirements:**
    - Task illuminance (lux)
    - Task illuminance uniformity (e.g. uniform (0.8), nonuniform (as appropriate))
    - Light colour rendering quality and index (Ra)
    - Average installed power density target ( $\text{W/m}^2$ ), to meet building energy code
    - Light pollution, sustainable lighting design
  - **Task lighting requirements:**
    - Task illuminance (lux)
    - Task illuminance uniformity (e.g. uniform (0.8), nonuniform (as appropriate))
    - Light colour rendering quality and index (Ra)
    - Average installed power density target ( $\text{W/m}^2$ ), to meet building energy code
    - Light pollution, sustainable lighting design
  - **Room lighting requirements:**
    - Accent lighting (e.g. display lighting, decorative lighting)
    - Wall lighting (e.g. display lighting, lighting to create room lightness)
    - Ceiling lighting (e.g. lighting to create room lightness)
    - Light colour appearance (e.g. warm, intermediate, cool)
    - Emergency and/or escape lighting requirement

### 3.6.2 Typical Calculations

- To calculate the amount of light that will result from a design
  - Critical for commercial & institutional buildings
  - Seldom required for residential design
- Basic considerations
  - Light sources (lamp lumens)
  - Luminaires & light distribution
  - Initial vs. maintained light levels (as lamps age and luminaires get dirty, light level drops)
- Design calculations for simple situations
  - The number and layout of luminaires needed for general lighting
  - What additional luminaires are needed to provide local emphasis or accents
  - Energy efficiency of the installation and financial benefits
- **Calculation methods:**
  - Manual, data sheets/tables, graphical, spreadsheet, computer software
- Determine illuminance level
  - Horizontal (most common)
    - Average illumination on the work plane (lux)
    - Sitting 0.75 to 0.9 m; Standing 0.85 to 1.2m
  - Vertical (e.g. on wall surface)
  - Inclined
- Analyse light distribution
  - Using light distribution curves, illumination and isolux diagrams
    - Illuminance (lux) or luminance ( $\text{cd/m}^2$ )
- Predict general & ambient light levels

- Rough estimation based on a **Watts/sq.m method**
  - Not very accurate, but good for prelim. planning
- **Lumen method calculations (light flux method)**
  - Determines average illuminance in large open areas
  - Good for general lighting
- **Point-by-point computer calculations**
  - Determines light levels at a specific point on an object or surface; complicated, start from fundamental laws
  - Can be used for outdoor lighting

### Rough estimation based on a Watts/sq.m method

Average light level desired & typical application	Watts/sq.m of fluorescent, CFL or HID lights	Watts/sq.m of incandescent or halogen lamps
25-50 lux Hotel corridors, stair towers	1-2	3-7
50-100 lux Office corridors, parking garages, theatres (house lights)	2-4	7-10
100-200 lux Building lobbies, waiting areas, malls, hotel function spaces	4-8	10-20
200-500 lux Office areas, classrooms, lecture halls, conference rooms, ambient retail lighting, workshops	15-25	Not recommended
500-1000 lux Grocery stores, laboratories, work areas, big box retail stores	12-20	Not recommended

- Predict task lighting & focal lighting levels
  - Difficult to predict accurately
  - Methods commonly used
    - Use data/guide of the luminaire's manufacturer
    - Use the inverse-square law to estimate
    - Use a display lighting software program
- **Lumen Method:**
  - Lumen Method: average illuminance ( E ) is

$$E = \frac{F \times n \times N \times UF \times MF}{A}$$

- F = initial bare lamp luminous flux (lumens)
- n = number of lamps per luminaire

- N = number of luminaires
- UF = utilisation factor
- MF = maintenance factor
- A = area of the surface (m<sup>2</sup>)

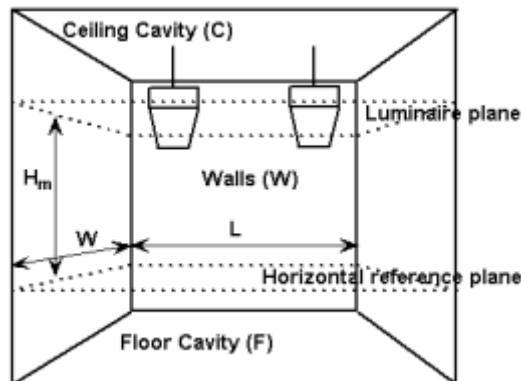

- Room index (K): a measure of the proportions of the room, for rectangular room
  - $K = (L \times W) / (L + W) h_m$ 
    - L = length of the room
    - W = width of the room
    - h<sub>m</sub> = height of luminaire above horiz. reference plane
- Effective reflectances of ceiling, walls & floor
  - Cavity index (CI) =  $(L \times W) / (L + W) h = K \times h_m / h$ 
    - h = depth of the cavity (ceiling or floor)
  - Determine effective reflectance from tables or formulae
- Utilisation factor (UF)
  - Ratio of total flux received by the surface to the total lamp flux of the installation
    - Indicates the effectiveness of the lighting scheme
  - UF depends upon: the efficiency of luminaire, luminaire distribution, geometry of the space, room reflectance, polar curve
  - Usually, UF tables are prepared for general lighting with regular arrays of luminaires, for 3 main room surfaces: ceiling cavity, walls, and floor cavity or horizontal reference plane
- Maintenance factor (MF)
  - Ratio of maintained illuminance to initial illuminance (losses for lamp lumen maintenance) •  $MF = LLMF \times LSF \times LMF \times RSMF$
  - Lamp lumen maintenance factor (LLMF)
  - Lamp survival factor (LSF)
  - Luminaire maintenance factor (LMF)
  - Room surface maintenance factor (RSMF)
  - See CIBSE/SLL Code of Lighting for description

## Maintenance factor and light depreciation

Environmental condition	Maintenance factor
Clean	0.9
Average	0.8
Dirty	0.7

- The number of luminaires required for a required illuminance level  $E$  (lux) is:

$$N = \frac{E \times A}{F \times n \times UF \times MF}$$

- Planning the luminaire layout
  - Work out a regular layout of luminaires with an acceptable uniformity
  - Rounding the number found to a whole number that will divide into a regular grid
  - Check on the spacing to height ratio

Luminaire layout and spacing

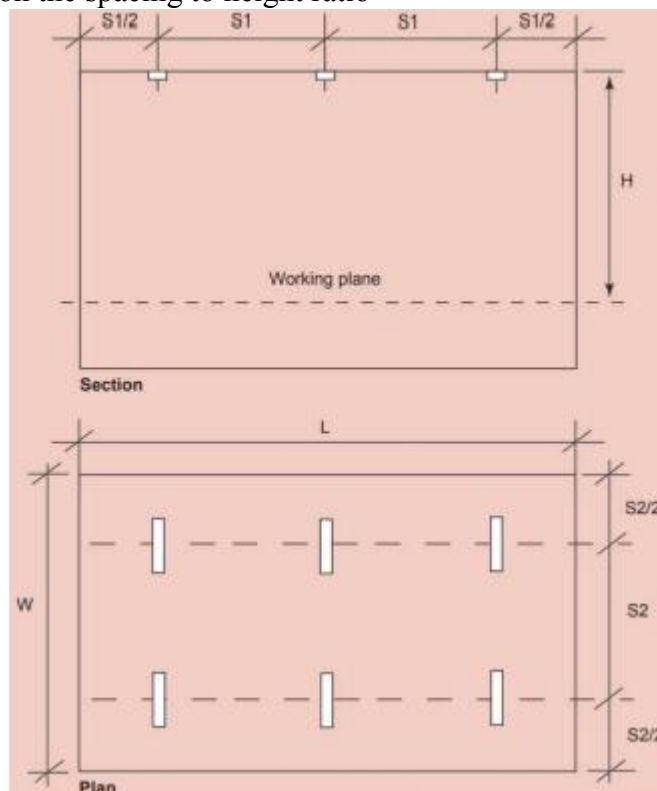

- Spacing to height ratio (SHR)
  - Ratio of distance between adjacent luminaires (centre to centre) to their height above the working plane

$$SHR = \frac{1}{H_m} \sqrt{\frac{A}{N}}$$

- where H m = mounting height; A = total floor area; N = number of luminaires
- Maximum spacing to height ratio (SHRmax )
  - Luminaire spacing shall not exceed the max. (provided by manufacturer) to ensure uniformity
- **Lumen method: calculation procedure --- a summary**
  - Calculate room index K, floor/ceiling cavity index
  - Calculate effective reflectances of ceiling cavity, walls & floor cavity
  - Determine utilisation factor (UF) from manufacturer's data, using the room index and effective reflectances
  - Determine maintenance factor (MF)
  - Obtain nos. of luminaires required
  - Determine a suitable layout
  - Check that the geometric mean spacing-to-height ratio
  - Check the layout does not exceed SHRmax
  - Calculate illuminance achieved by the final layout
- Basic assumptions underlying the lumen method
  - Rectangular room
  - Ratio of length to width = 1.6 : 1, with a max. of 4 : 1
  - Completely empty room
  - Uniform reflectance and completely diffuse reflection properties of the perimeter surfaces
  - Uniform distribution of luminous flux over all areas
  - Regular luminaire configuration throughout the room
  - In the case of fluorescent lamps, luminaire axis = room axis
- Examples of lumen method calculations:
  - Lighting Design Calculation in a Building – Step by Step  
<http://www.electricaltechnology.org/2017/03/lighting-design-calculation-in-building.html>
  - Lumen method calculations  
[http://www.arca53.dsl.pipex.com/index\\_files/lummethd.htm](http://www.arca53.dsl.pipex.com/index_files/lummethd.htm)
  - The installer's guide to lighting design, Good Practice Guide 300 (page 22-26)  
<http://www.cibse.org/getmedia/0276ac78-dc41-4694-9378-8f984ef924f2/GPG300-The-Installers-Guide-to-Lighting-Design.pdf.aspx>

### Point-by-point Method

- Predict direct illuminance at each point on a plane, using measured data of luminous intensity distribution of a source or a luminaire
  - Based on the inverse square law and cosine law
- Three factors must be considered:
  - Luminous intensity
  - Distance
  - Orientation of the surface

## Inverse Square Law for lighting calculations

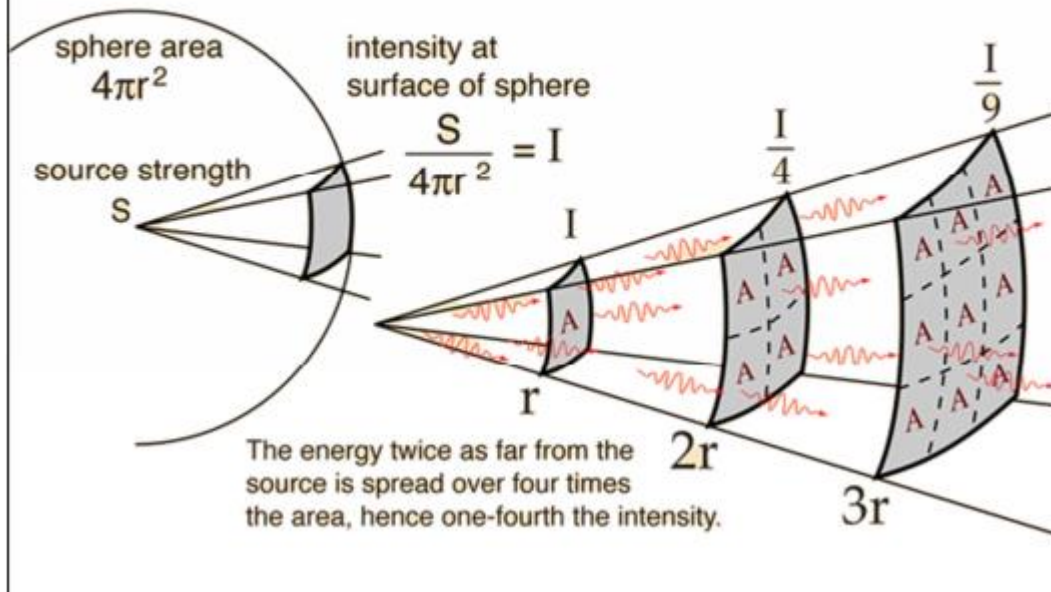

## Cosine Law for lighting calculations

### COSINE LAW (Illuminance on Tilted Surface)

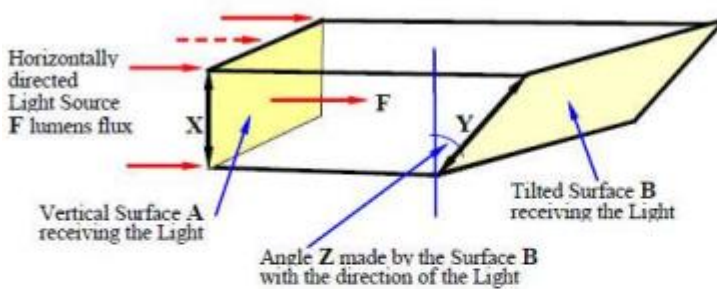

The Areas A and B are proportional to the lengths of their sides X and Y

$$A/B = \cos(Z) \quad B = A / \cos(Z) \quad \text{Illuminance } E_A = F/A$$

$$\text{Illuminance } E_B = F/B = F / (A / \cos(Z)) = F/A * \cos(Z) = E_A * \cos(Z)$$

$E = I/D^2$  when the incident angle is 0 degrees.  
The general equation becomes  $E = I/D^2 * \cos(Z)$

Light Source Intensity = I Candelas  $E = I/D^2$

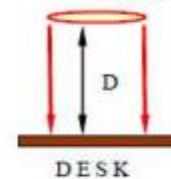

Light Source Intensity = I Candelas  $E = I/D^2 * \cos(Z)$

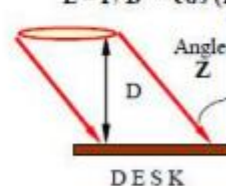

### Cosine Values of Angles

0	6	12	18	24	30	36	42	48	54	60	66	72	78	84	90
1.000	0.995	0.978	0.951	0.914	0.866	0.809	0.743	0.669	0.588	0.500	0.407	0.309	0.208	0.105	0.000

- Limits for using point by point method:
  - Maximum physical dimension of the surface under design is not larger than 1/5th the mounting height above the evaluation point
  - Does not apply to a surface of infinite length
- Computer software can be used to perform numerical point-by-point calculations of direct or reflected light incident on any real surface or imaginary plane
  - The results can be used to predict or quantify the distribution of artificial or natural light in any environment (lighting simulation)
  - Brightness of room surfaces and patterns of light on the ceiling, walls, and floor
  - Also lighting quality & visual performance



- Two calculation techniques when simulating a lighting application
- Direct Calculation Method
  - A simplified technique when reflected light need not be considered in the results; often used in exterior lighting applications e.g. road and sports lighting
  - It cannot be rendered
- Full Radiosity Method
  - Accurate computation of interreflected light; for interior lighting applications or when rendering is desired

Two calculation techniques for simulating a lighting application

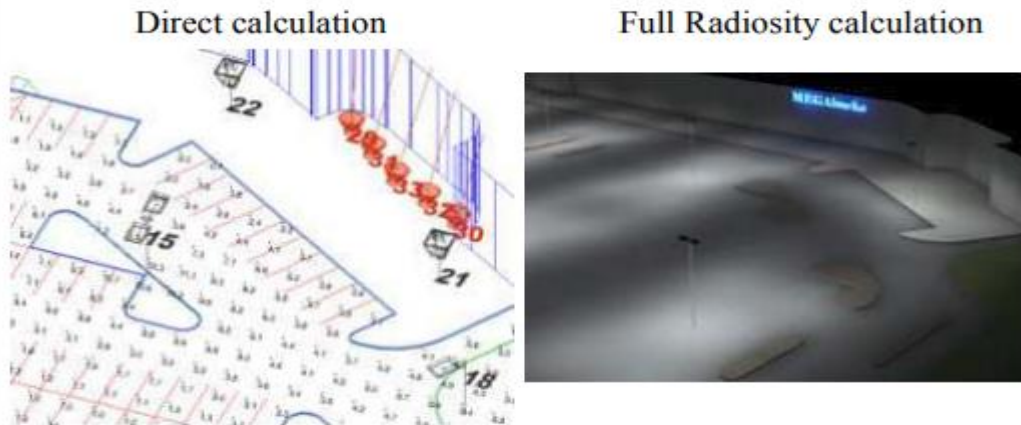

Lighting calculations and simulation in Revit BIM using ElumTools

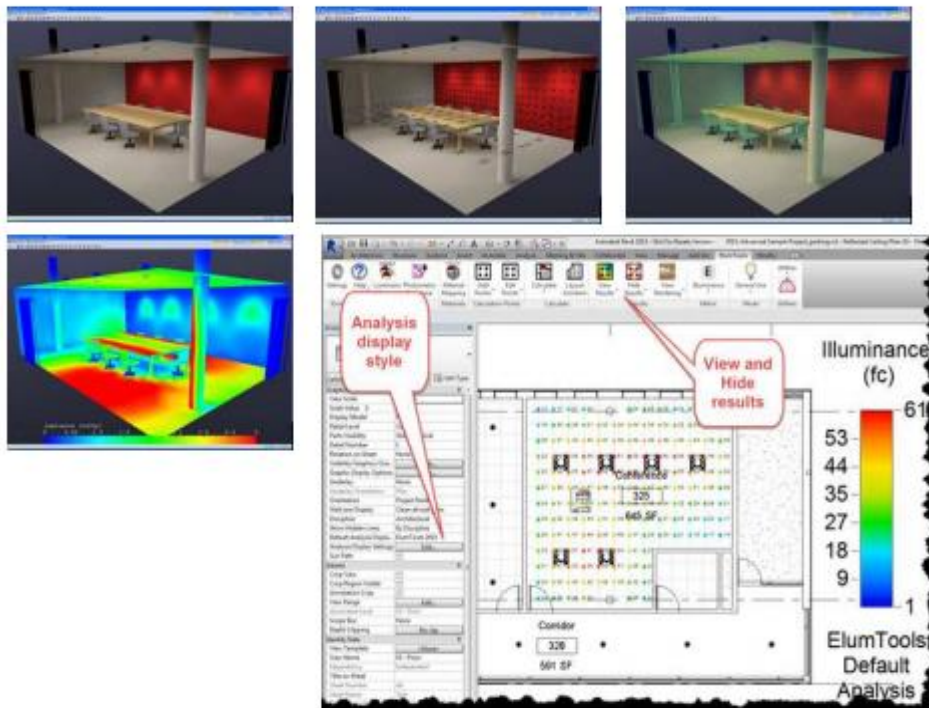



Using isolines and spatial maps to evaluate the gradient of light across a workplane or surface

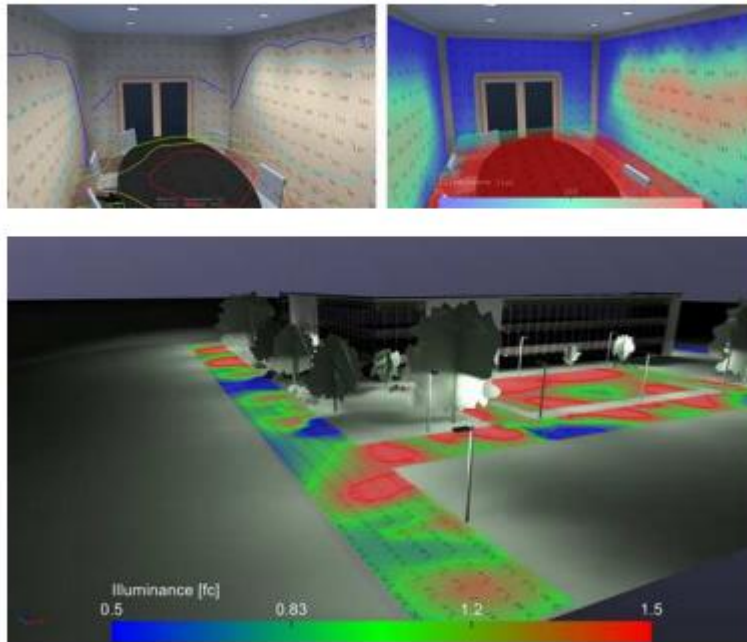

### 3.5.3 Other Calculations

- Lighting to provide local emphasis
  - Emphasis or accent lighting is used to draw attention to an area or an object, e.g. a reception desk in an entrance area or a display in a shop
  - The amount of light needed to emphasise or draw attention to an object depends on the level of general lighting
  - Ratio of display light to general lighting:
    - ‘Subtle’ effect --- 5 : 1
    - ‘Moderate’ emphasis --- 15 : 1
    - ‘Strong’ emphasis --- 30 : 1
- Example: Use spotlight for local emphasis
  - Manufacturers usually provide information in a diagrammatic form showing the effect of a particular spotlight at various distances
    - Width of the beam and either the illuminance at the beam centre or the average illuminance across the beam
    - Calculate the illuminance from a spotlight or any other small source using the ‘point source formula’
  - Wall washing: This uses luminaires that usually have an asymmetric beam shape. The manufacturers usually provide details of the luminaire layout and illuminance performance

## Typical performance data for spotlight and wall-washing luminaire

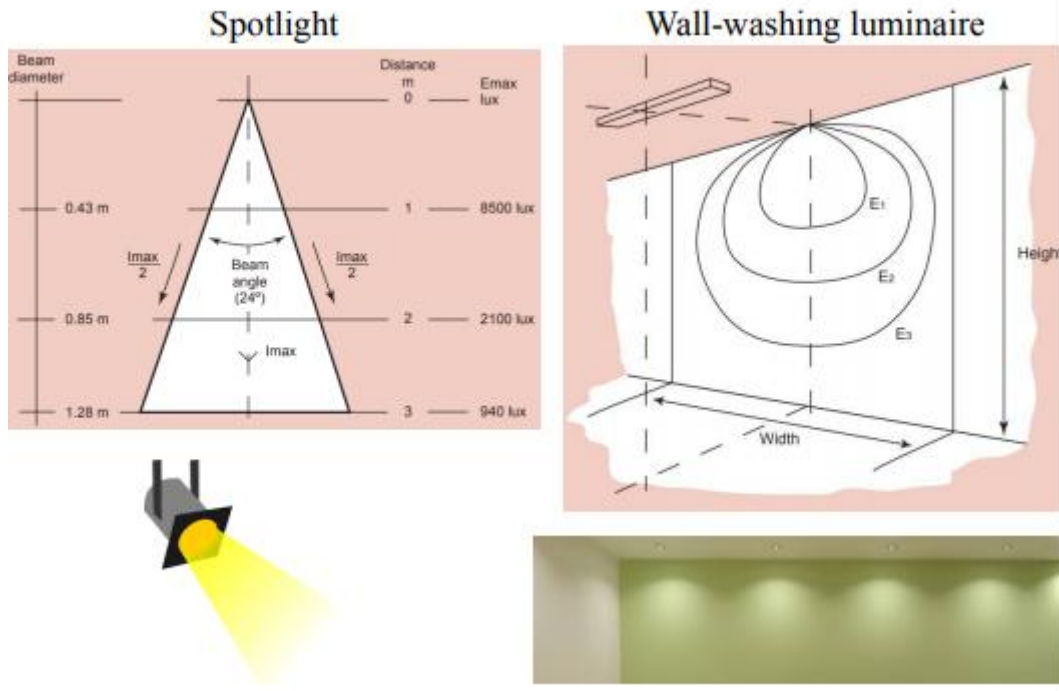

- Outdoor area lighting design, such as floodlighting, sports and road lighting
  - Area lighting Design Calculations - Part One  
<http://www.electrical-knowhow.com/2013/01/area-lighting-design-calculations-part.html>
- Daylighting and daylight factor
- <http://personal.cityu.edu.hk/~bsapplec/methods.htm>
- Other lighting system related calculations:
  - Checking for energy efficiency
    - Local building/lighting energy efficiency code
    - Average installed power density ( $W/m^2$ )
  - Energy-saving payback calculations
    - Demonstrate to a client that the additional cost of installing efficient equipment is worthwhile is by calculating payback period – the length of time before the savings match the extra initial cost
    - Payback = (the extra initial cost) / (annual cost savings)
  - After this period, the user has saved more than he has spent and continues to save money

### 3.5.4 Outdoor Lighting

- Outdoor (or exterior) lighting
  - Floodlighting: flooding a surface with light
    - Achieve illumination on vertical or horizontal surfaces
  - Design issues
    - Appearance during daytime
    - Glare from the installation
    - Decorative lighting

- Lighting for specific outdoor activities e.g. sports
- Applications:
  - Building façade, sports, road lighting
- Floodlighting a building
  - Requires a sense of drama and colour
  - Select locations for putting floodlights & aiming points
  - Peak intensity & beam angle
  - Usually all the beams from each floodlight shall overlap
  - Uniformity ratio (max : average) about 5:1
- Floodlighting a horizontal open area
  - Use isolux diagram (horizontal illumination plots)
  - Or isocandela and zonal flux diagram
  - Calculate using inverse square law and cosine law