

# Electrical Energy Conservation and Auditing

By

**Dr. Yogesh Kumar Nayak**

**Assistant Professor**

**Department of Electrical Engineering**

**Government Collage of Engineering, Keonjhjar-758002**

## Module I: (12 Hours)

**Electrical energy conservation:** Energy economics- discount rate, payback period, internal rate of return, net present value, and life cycle cost. Energy generation, energy distribution, energy usage by processes, technical and economic evaluation, understanding energy costs, classification of energy conservation measures, plant energy performance, benchmarking and energy performance, matching energy usage to requirement, maximizing energy system efficiency, optimizing the input energy requirements, fuel and energy substitution, and energy balancing.

**EB billing-** HT and LT supply, transformers, electric motors- motor efficiency computation, energy efficient motors, pumps, fans, blowers, compressed air systems, refrigeration and air conditioning systems, cooling towers, electric heaters (space and liquid), DG-sets, illuminating devices, power factor improvement, and harmonics.

### Electrical energy conservation

Electrical energy is the most common and widely used type of energy in the world. The subject of energy conservation is a concern for most energy users particularly industry. Energy conservation (ECON) becomes even more important for the third world, developing countries, where the rising energy costs and the use of efficient energy apparatus are of significant concern to both the industry and the utility.

In this Module, the application of the ECON techniques by which electrical energy can be saved and made cost efficient from the industrial perspective are presented for a Thermal Power Plant

Areas of application of Energy Conservation are Power Generating Station, Transmission & Distribution system, Consumers premises. Steps are to be taken to enhance the performance efficiency of generating stations.

Energy Conservation technology adopted in Transmission & Distribution system may reduce energy losses, which were in tune of 35% of total losses in Power system. Acceptance of Energy conservation technology will enhances the performance efficiency of electrical apparatus used by end users.

Implementation of Energy conservation technology will lead to energy saving which means increasing generation of energy with available source.

## 1.0 Need of energy conservation:

Fossil fuels like coal, oil that has taken years to form is on the verge of depleting soon. In last 200 years we have consumed 60% of all resources. For sustainable development we need to adopt energy efficiency measures. Today 85% of primary energy sources come from non-renewable and fossil sources. These reserves increasing consumption and will exist for future generations.

Energy survey conducted by Ministry of Power in 1992 revealed that there is requirement of improvement in energy generation efficiency, improvement in energy transportation (transmission & distribution systems) and enhancing the performance efficiency of use end apparatus. Study of 'Energy strategies for Future' evolved two things - efficient use of energy, energy conservation and use of Renewable Energy. Energy conservation emerges out to be the first and least cost option.

## 1.1 Important terms and definitions

**The formal definition of the basic terms are given below**

The formal definitions of the basic terms are given below:

### **Energy Policy**

Energy Policy defines the overall guidelines for the efforts to achieve greater energy efficiency. It is established and maintained by the top management of the company.

### **Energy Planning**

Energy Planning involves setting of concrete energy targets complying with the overall energy policy and elaborate action plans to achieve the targets in a given time frame. Planning of several activities includes, forecast, budget, infrastructure, material, equipment, technology, financial resource, human resource and R & D planning.

### **Energy management**

Energy management can be defined in many ways. One way of defining it is: "The judicious and effective use of energy to maximize profit and enhance competitive positions" another comprehensive definition is: "The strategy of adjusting and optimizing energy, using systems and procedures so as to reduce energy requirements per unit of output while holding constant or reducing total cost of producing the output from these systems"

The objective of energy management is to achieve and maintain optimum energy procurement and utilization throughout the organization and to: (i) minimize energy cost/energy waste without affecting production and quality, (ii) minimize environmental effects.

### **Energy Audit**

Energy audit is an inspection, survey and analysis of energy flows for energy conservation in a building, process or system to reduce the amount of energy input into the system without negatively affecting the output(s). It also includes submission of technical report containing recommendations for improving energy efficiency with cost benefit analysis and an action plan

to reduce energy consumption. In commercial and industrial real estate, an energy audit is the first step in identifying opportunities to reduce energy expense.

The primary objective of Energy Audit is to determine ways to reduce energy consumption per unit of product output or to lower operating costs. Energy Audit provides a “benchmark” (reference point) for managing energy in the organization and also provides the basis for planning a more effective use of energy throughout the organization.

### **Energy conservation**

Energy conservation means reduction in growth of energy consumption and is measured in physical terms.

Energy conservation is the practice of decreasing the quantity of energy used while achieving a similar outcome of end use. (This practice may result in increase of financial capital, environmental value, national security, personal security and human comfort.)

Energy conservation also means reduction or elimination of unnecessary energy used and wasted.

### **Energy Efficiency**

Energy Efficiency is define saving energy, but keeping the same level of service. For example, replace an inefficient incandescent light bulb with a more efficient compact fluorescent lamp for an LED lamp. On the other hand, if you turn off the lights when you leave a room, you are practicing energy conservation

### **Energy Conservation vs. Energy Efficiency: What is the difference?**

Energy conservation and efficiency may be related, but they have distinct definitions in the energy world. Energy conservation involves using less energy by adjusting your behaviours and habits. Energy efficiency, on the other hand, involves using technology that requires less energy to perform the same function. Energy-saving light bulbs, large household appliances, smart thermostats, and smart home hubs like Constellation Connect are all examples of technology that can be energy efficient.

### **Energy intensity**

Energy intensity is a measure of the energy efficiency of a nation’s economy. It is calculated as the amount of energy consumed for generating one unit of Gross Domestic Product.

### **Energy elasticity**

Energy elasticity is the percentage change in energy consumption to achieve one percent change in national GDP in a specific country over time

### **Energy Conservation act 2001**

- Enacted on 1st October 2001
- Becomes effective from 1st March 2002
- Objective of providing necessary legal Framework for promoting energy conservation measures in the country
- Bureau of Energy Efficiency of operationalised from 1st March 2002

## **Purpose of the EC act 2001**

- The purpose of this act is to provide for efficient use of energy and its conservation
- Provide a policy framework and direction to National energy conservation activities
- Co-ordinate policies and programs on efficient use of energy with stakeholders
- Established systems and procedure to verify measure and monitor improvement
- Leverage multilateral bilateral and private sector support to implement the EC act
- Demonstrate the delivery systems through public-private partnerships
- To promote Energy Efficiency in this country

## **Important features of energy conservation act 2001**

- Energy conservation Building Code (ECBC)
- Standards and labelling (S&L)
- Demand side management (DSM)
- Bachat lamp Yojana (BLY)
- Promoting Energy Efficiency in small and medium enterprises (SMEs)
- Designated consumers
- Certification of energy managers and energy auditors

## **1.2 Important Aspects of Energy Conservation**

Conserving usable energy, which is otherwise wasted, has a direct impact on economy, environment and long-term availability of non-renewable energy sources. Energy conservation implies reduction in energy consumption by reducing losses and wastage by employing energy efficient means of generation and utilization of energy. There are three important aspects of energy conservation:

### **1.2.1. Economic Aspect**

**(A) Reduction in cost of product** Energy conservation ultimately leads to economic benefits as the cost of production is reduced. In some energy intensive industries like steel, aluminium, cement, fertilizer, pulp and paper etc., cost of energy forms a significant part of the total cost of the product. Energy cost (expressed as percent of total cost of the product) in the entire industrial sector in India varies from as low as 0.36 per cent to as high as 65 per cent. We must strive for good energy economy using energy efficient technologies. This will reduce the manufacturing cost and lead to production of cheaper and better quality products. This is essential to stay competent with our commercial rivals.

**(B) New job opportunities** Energy conservation usually requires new investments in more efficient equipment to replace old inefficient ones, monitoring of energy consumption, training of manpower, etc. Thus, energy conservation can result in new job opportunities.

### **1.2.2 Environment Aspect**

Every type of energy generation / utilization process affects the environment to some extent either directly or indirectly. The extent of degradation of environment depends mainly on the type of primary energy source. Also during any energy conversion stage a part of energy escapes to surroundings and appears in the form of heat. Thus energy is generated and utilized

at the expense of adverse environmental impacts. Adoption of energy conservation means can minimize this damage.

### **1.2.3 Conservation of Non Renewable Energy Assets**

The vast bulk of energy used in the world today comes from fossil fuels, which are non-renewable. These resources were laid down many millions of years ago and are not being made any longer. This finite, non-renewable asset is being used up very fast. The quantity of fossil fuels the world community uses up in one minute what it took the earth a millennium to create. Therefore, its prices are bound to go up relative to everything else. We must abandon wasteful practices in energy utilization and conserve this resource by all means for future generations.

### **Salient features of energy conservation act 2001**

The Act provides a long-range consequence, which is appended below:

- The establishment of Bureau of Energy Efficiency (BEE) in place of existing Energy Management Centre (EMC) to implement the provisions of the act
- Declaration of a user or class of users of energy as a designated consumer
- To lay down minimum energy consumption standards and labeling for identified appliances/equipment and norms for industrial processes for energy intensive industries
- Formation of energy consumption codes
- Dissemination of information and best practices
- Establishment of Energy Conservation Fund both at the central and state levels
- Provision of penalties and adjudication
- The BEE would act as a facilitator for the evolution of a self-regulatory system and organizations would regulate on their own with a view to save energy and thereby bring the commercial concept in the organization

The Central Government has established the BEE with effect from March 1, 2002. Further, the provision of sections 1–29 and sections 46–62 of the Energy Conservation Act 2001 relating to this have come into force from the same date.

### **Schemes to promote energy conservation and energy efficiency [22]**

Ministry of Power, through Bureau of Energy Efficiency (BEE), has initiated a number of energy efficiency initiatives in the areas of household lighting, commercial buildings, standards and labeling of appliances, demand side management in agriculture/municipalities, SMEs (Small and Medium Enterprises) and large industries including the initiation of the process for development of energy consumption norms for industrial sub sectors, capacity building of SDAs (State Designated Agencies), etc. The target of energy savings against these schemes during the XIth Plan period was kept as 10,000 MW of avoided generation capacity. These initiatives have resulted in an avoided capacity generation of 10836 MW during the XIth plan period. The schemes initiated by BEE are discussed below:

## 1. Standards and Labeling

The Bureau initiated the Standards and Labeling (S and L) programme for equipment and appliances in 2006 to provide the consumer an informed choice about the energy saving and thereby the cost-saving potential of the relevant marketed product. The scheme is invoked for 19 equipment/appliances, i.e. Room Air-Conditioners, Fluorescent Tube Lights, Frost Free Refrigerators, Distribution Transformers, Induction Motors, Direct Cool Refrigerator, electric storage type geyser, Ceiling fans, Color TVs, Agricultural pump sets, LPG stoves, Washing machine, Laptops, ballast, floor standing ACs, office automation products, Diesel Generating sets & Diesel operating pump sets of which the first 4 products have been notified under mandatory labeling from 7<sup>th</sup> January, 2010. The other appliances are presently under voluntary labeling phase. The energy efficiency labeling programmes under BEE are intended to reduce the energy consumption of appliance without diminishing the services it provides to consumers. Further, the standards and label for refrigerators and air-conditioners have been periodically made more stringent. As a result, the least-efficient products are removed from the market and more efficient products are introduced. The Corporate Average Fuel Consumption Standards (CAFC) for passenger cars has been notified on 30th January, 2014. The most recent additions to the list of labeled products are Diesel Pump Sets & Diesel Generating Set.

During the XII<sup>th</sup> plan, Standards and Labelling programme will target at least 3 more new equipment/appliances including upgradation of energy performance standards for equipment/appliances covered during XI Plan.

## 2. Energy Conservation Building Codes (ECBC)

The Energy Conservation Building Code (ECBC) was developed by Govt. of India for new commercial buildings on 27th May 2007. ECBC sets minimum energy standards for new commercial buildings having a connected load of 100 kW or contract demand of 120 KVA and above. While the Central Government has powers under the EC Act 2001, the state governments have the flexibility to modify the code to suit local or regional needs and notify them. Currently eight States and Union Territories (Rajasthan, Odisha, UT of Puducherry, Uttarakhand, Punjab, Karnataka, Andhra Pradesh & Telangana) notified and adopted the code for their states. In order to promote a market pull for energy efficient buildings, Bureau of Energy Efficiency developed a voluntary Star Rating Programme for buildings which is based on the actual performance of a building, in terms of energy usage in the building over its area expressed in kWh/sq. m/year. Currently, Voluntary Star Labelling programme for 4 categories of buildings (day use office buildings / BPOs / Shopping malls / Hospitals) has been developed and put in public domain.

## 3. Demand Side Management (DSM) Schemes

**(a) Agriculture DSM** In order to tap the energy saving potential, Agriculture Demand Side Management (AgDSM) programme was initiated in XI<sup>th</sup> plan by Bureau of Energy Efficiency with an objective to induce energy efficiency in agriculture sector by creating market based framework for implementation of few pilot projects and create awareness among end users and other stakeholders for adoption of energy efficient pump sets (EEPS).

During the XII<sup>th</sup> plan, realizing the vast energy saving potential in the sector, BEE intends to continue the programme with an objective to build up the process of acceleration of sustainable energy efficiency in the plan through following interventions:

- Regulatory mechanism to mandate the use of BEE star labeled pump sets for new connections
- Facilitate implementation of DPRs and setting up monitoring & verification protocol
- Technical assistance and capacity development of all stakeholders

**(b) *Municipal DSM*** Identifying the immense energy-saving potential in municipal sector, BEE initiated Municipal Demand Side Management (MuDSM) during XI plan. The basic objective of the project was to improve the overall energy efficiency of the Urban Local Bodies (ULBs), which could lead to substantial savings in the electricity consumption, thereby resulting in cost reduction / savings for the ULBs. Implementation of the project at the ground level is highly necessary which will create a market transformation among technology provider, implementing partners, financial institutions etc. In view of these facts, it is proposed that implementation of demo projects in 15 ULBs will be undertaken on pilot basis during XII plan. In addition, technical support will be provided to the ULBs by appointing technical experts to selected ULBs.

**(c) *Capacity Building of DISCOMS*** The objective of the programme is capacity building of DISCOMs (distribution companies) for carrying out load management programme, energy conservation programme, development of DSM action plan and implementation of DSM activities in their respective areas. This programme would help the DISCOMs for reducing peak electricity demand so that they can delay building further capacity.

**(d) *Energy Efficiency in Small and Medium Enterprises (SMEs)*** Sector To encourage the energy efficient technologies and operational practices in SME sectors in India, BEE has initiated the energy efficiency interventions in selected 25 SMEs clusters during the XI<sup>th</sup> plan. A study was conducted to assess energy use and technology gap at unit level, development of the cluster specific energy efficiency manuals, preparation of Detailed Project Reports (DPRs) on energy efficient technologies and capacity building and knowledge enhancement of man-force involved in SMEs. During the XII<sup>th</sup> plan, implementations of 100 technology demonstration projects in five SME sectors are envisaged to facilitate large-scale replication.

#### **4. Strengthening Institutional Capacity of States**

**(a) *Strengthening of State Designated Agency (SDAs)*** As has been mentioned earlier, the implementation and enforcement of the provisions of the Energy Conservation Act in the states is to be carried out by SDAs. As on date, the SDAs have been set up in 32 states by designating one of the existing organizations as required under Section 15 (d) of the Energy Conservation Act 2001. In order to kick start the energy conservation activities at the state level with an emphasis on building institutional capacities of the SDAs, Ministry of Power had approved the scheme of Providing financial assistance to the State Designated Agencies for strengthening their institutional capacities and capabilities during the XI plan. During the XII plan, thrust is given on establishment of the enforcement machinery at the State level.

**(b) *Contribution to State Energy Conservation Fund (SECF) Scheme*** The State Energy Conservation Fund (SECF) is an instrument to overcome the major barriers for implementation of energy efficiency projects. The contribution under State Energy Conservation Fund (SECF) was made to those State Govt. / UT Administration who have created their SECF and finalized the rules and regulations to operationalize the same.



## **5. School Education Programme**

Considering the need to make the next generation more aware regarding efficient use of energy resources, it is necessary to introduce children during their school education. In this regard, promotion of energy efficiency in schools is being promoted through the establishment of Energy Clubs. Bureau of Energy Efficiency is implementing the Students Capacity Building Programme under Energy Conservation awareness scheme for XII five year plan and intends to prepare the text / material on Energy Efficiency and Conservation for its proposed incorporation in the existing science syllabi and science textbooks of NCERT for classes 6th to 10th.

Through this project recommendations will also be made to the National Council of Education, Research and Training (NCERT) to update the science textbooks of classes VII to IX to include relevant chapters on Energy Efficiency in the school syllabus.

## **6. Human Resource Development (HRD)**

The potential for improvement of energy efficiency of processes and equipment through awareness creation is vast. A sound policy for creation, retention and up gradation of skills of Human Resources is very crucial for penetration of energy efficient technologies and practices in various sectors. The component under HRD comprises of theory cum practice oriented training programme and providing Energy Audit Instrument Support.

## **7. National Mission for Enhanced Energy Efficiency (NMEEE)**

The National Mission for Enhanced Energy Efficiency (NMEEE) is one of the eight missions under the National Action Plan on Climate Change (NAPCC). NMEEE aims to strengthen the market for energy efficiency by creating conducive regulatory and policy regime and has envisaged fostering innovative and sustainable business models to the energy efficiency sector.

The Mission seeks to upscale the efforts to unlock the market for energy efficiency which is estimated to be around Rs. 74,000 crore and help achieve total avoided capacity addition of 19,598 MW, fuel savings of around 23 million tonnes per year and greenhouse gas emissions reductions of 98.55 million tonnes per year at its full implementation stage.

### **1.3 Area of application of Energy Conservation:**

Electrical system is a network in which power is generated using non-renewable sources by conventional method and then transmitted over longer distances at high voltage levels to load centers where it is used for various energy conversion process. End user sector are identified as three major areas -Power Generating station, Transmission & Distribution systems, and Energy consumers. Consumers are further classified as Domestic, commercial and Industrial consumers.

Areas	Consumption (Year-2007)
Domestic	21%
Commercial	18.0%
Industrial	32%
Transportation	29%

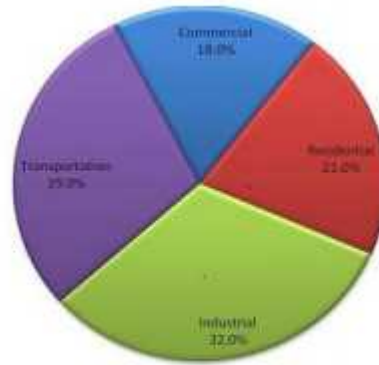

## ENERGY CONSERVATION OPPORTUNITIES

### Classification of energy conservation opportunities

Based on energy audit and analyses of the plant, a number of potential energy saving projects may be identified. These may be classified into three categories:

#### 1. Category A: Minor ECOs

Minor ECOs are simple, easy to implement, requiring less investment and implementation time. These are related with stopping of leakage points, avoiding careless waste, housekeeping, lapses and carelessness of O & M personnel.

#### 2. Category B: Medium ECOs

Medium ECOs or intermediate ECOs are slightly complex, requiring additional investment and moderate implementation time.

#### 3. Category C: Major ECOs

Major ECOs provide significant energy conservation opportunity. These are high tech., complex and require heavy investment and long implementation period.

### General electrical ecos

#### 1. Class A: Simple Electrical ECOs

- (a) Switching off the loads (i.e. lights, heaters, ACs, TVs, etc.) when not in use
- (b) Changing from electrical heating to solar heating or gas burner heating wherever possible
- (c) Proper housekeeping
- (d) Reducing peak demand by staggering the use of large loads
- (e) Providing automatic thermostatic (or any other) control to water heaters, refrigerators, air-conditioners, etc.
- (f) Using recently developed 'tiny switches' which switch off the electronic apparatus during their sleeping mode
- (g) Changing operating cycle of electrical equipment to conserve energy.

For example, electrical furnaces may be used continuously in three shifts (instead of two shifts) for better economy.

(h) Replacing inefficient lamps by energy efficient lamps

## **2. Class B: Intermediate Electrical ECOs**

(a) Installation of static VAR sources at substations

(b) Employing automatic controlled load switches

(c) Heat recovery from cooling oil associated with transformer

(d) Automatic voltage control of power consuming devices by means of ON-load tap changer

(e) Installation of shunt capacitors near inductive load for power factor improvement and reducing kVA demand

(f) Improvement in Operation and Maintenance, reducing down time

## **3. Class C: Comprehensive Electrical ECOs**

(a) Modern more efficient and easy to maintain plant equipment may replace old less efficient ones

(b) The simple manual / semi manual controlled equipment in an electrical plant are retrofitted with energy efficient computer controlled equipment. The energy input is matched with optimum energy requirement.

## **1.4 ENERGY CONSERVATION TECHNIQUES:**

### **1.4.1 EC in Power generating station:**

To generate 1MW power generation cost is Rs 4.5 to 5.25 crores and T& D cost is Rs.2 crores. But cost of saved power is Rs.1Crores/Mw. The important note is time period to set a power plant is 5 years; to set up transmission line 1 year and to plan energy conservation is only 1 month. We have less opportunity for EC in generating area but we can improve the performance efficiency of generators by optimization of load, optimal distribution of load among different units, periodical maintenance and also increasing the capacity by adopting advanced technology using renewable energy sources.

### **1.4.2 EC in Transmission & Distribution:**

Areas Consumption (Year-2007) Domestic 21% Commercial 18.0% Industrial 32% Transportation 29% 3 In India the power transmission and distribution (T&D) system is a three tire structure comprising of state grids, regional grids and distribution network. To meet the energy demand power system networks are interconnected through INTRA-REGIONAL LINK.

The inter-regional power transmission capacity of India at end of 2007 was 14000 MW. T&D system in India is characterized by heavy losses of about 34.54% according to statistics of 2005-06, as compared to 10-15% in developed countries

Power losses in T&D system can be classified as Technical losses and Commercial losses.

Power losses in T&D system	
Technical losses	Commercial losses
<ul style="list-style-type: none"> <li>Transformer losses</li> <li>Transmission line losses</li> <li>Inter-link losses</li> <li>Distribution losses</li> </ul>	<ul style="list-style-type: none"> <li>Metering</li> <li>Inefficient management</li> <li>Improper maintenance</li> </ul>

#### 1.4.2.1- Technical Losses in T&D System:

Power losses occurring in T&D sector due to imperfection in technical aspect which indirectly cause loss of investment in this sector, are technical losses. These technical losses are due to inadequate system planning, improper voltage and also due to poor power factor etc.

Components	Nature of losses	% Losses
Transformer Losses	Electrical Losses = $I^2R$ losses Magnetic Losses = Core losses	Power transformer contributes nearly 40% to 50% of total transmission and distribution losses.
Transmission line losses:	Line losses = $3I^2R$ loss	17%
Inter-link losses:	Line losses = $3I^2R$ loss	
Distribution Losses:	$I^2R$ loss in distribution line High reactive burden. Poor p.f. Harmonic currents. Unbalanced load. Excessive neutral current.	These losses range from 10% to 62%. The average losses are found to be 25%.

#### 1.4.2.2-Commercial Losses:

Commercial losses are those, which are directly responsible for wastage of money invested in transmission and distribution system. These losses are effects of inefficient management, improper maintenance etc. Corruption is also the main reason contributing to the Commercial losses. Metering losses includes loss due to inadequate billings, faulty metering, overuse, because of meters not working properly and outright theft. Many of the domestic energy meters fail because of poor quality of the equipment.

#### 1.4.3 EC Techniques in Transformers:

##### i) Optimization of loading of transformer:

- By proper Location of Transformer preferably close to the load center, considering other features like centralized control, operational flexibility etc. This will bring down the distribution loss in cables.

- Maintaining maximum efficiency to occur at 38% loading (as recommended by REC), the overall efficiency of transformer can be increased and its losses can be reduced
- Under fluctuating load condition more than one transformer is used in Parallel Operation of Transformers to share the load & can be operated close to the maximum efficiency range

#### ii) By Improvisation in Design and Material of Transformer:

- To reduce load losses in Transformer, use thicker conductors so that resistance of conductor reduces and load loss also reduces.
- To reduce Core losses use superior quality or improved grades of Cold Rolled Grain Oriented (CRGO) laminations.

#### iii) Replacing by Energy Efficient Transformers:

- By using energy efficient transformers efficiency improves to 95 % to 97%.
- By using Amorphous transformers efficiency improves to 97 % to 98.5%.
- By using Epoxy Resin cast/ Encapsulated Dry type transformer- efficiency improves to 93% to 97%.

#### 1.4.4 Energy Conservation in Transmission Line:

To reduce line resistance-„R“ solid conductors are replaced by stranded conductors (ACSR or AAC) and by bundled conductors in HT line.

High Voltage Direct Current (HVDC) is used to transmit large amount of power over long distances or for interconnections between asynchronous grids

By transmitting energy at high voltage level reduces the fraction of energy lost due to Joule heating. ( $V \propto 1/I$  so  $I^2R$  losses reduces).

As load on system increases terminal voltage decreases. Voltage level can be controlled by using voltage controllers and by using voltage stabilizer

If required reactive power transmitted through transmission lines, it causes more voltage drop in the line. To control receiving end voltage, reactive power controllers or reactive power compensating equipments such as Static VAR controllers are used.

#### 1.4.5 Energy Conservation in Distribution Line:

**a) Optimization of distribution system:** The optimum distribution system is the economical combination of primary line (HT), distribution transformer and secondary line (LT), To reduce this loss and improve voltage HT/LT line length ratio should be optimized.

**b) Balancing of phase load-** As a result of unequal loads on individual phase sequence, components causes over heating of transformers, cables, conductors, motors. Thus, increasing losses and resulting in the motor malfunctioning under unbalanced voltage conditions.

**c) Harmonics:** With increase in use of non-linear devices, distortion of the voltage and current waveforms occurs, known as Harmonics. Due to presence of harmonic currents excessive voltage and current in transformers terminals, malfunctioning of control equipments and Energy meter, over effect of power factor correction apparatus, interference with telephone circuits and broad casting occurs. Distribution Static Compensator (DASTACOM) and Harmonic filters can reduce this harmonics.

**d) Energy Conservation by using power factor controller:** Low power factor will lead to increased current and hence increase losses and will affect the voltage. We can use Power Factor Controller or Automatic Power Factor Controller that can be located near receiving substations, load centres or near loads.

**e) Energy Conservation By Demand side management control:** Demand-side management is used to describe the actions of a utility, beyond the customer's meter, with the objective of altering the end-use of electricity - whether it be to increase demand, decrease it, shift it between high and low peak periods, or manage it when there are intermittent load demands - in the overall interests of reducing utility costs. Nearly energy of 15,000 MW can be saved through end-use energy efficiency.

By using DSM saving potential in...

Industry and Agriculture - 30-35%

Commercial / Government establishments and residential houses. -25-30%

**1.4.6 - Energy Conservation in lighting system:**

Good lighting is required to improve the quality of work, to reduce human's / worker's fatigue, to reduce accidents, to protect his eyes and nervous system. In industry it improves production, and quality of products / work. To view economy of lighting system, cost of initial installation cost, running cost, and effect on production / work are to be considered as main parameters. The power consumption by the industrial lighting is nearly 2 to 10 % of total power consumption, depending on type of industries.

**a) Optimum use of natural light:** Whenever the orientation of a building permits, day lighting has to be used in combination with electric lighting. The maximum use of sunlight can be get by means of transparent roof sheets, north light roof, etc

**b) Replacing incandescent lamps by Compact Fluorescent Lamps (CFL's):** CFL's are highly suitable for places such as Living rooms, Hotel lounges, Bars, Restaurants, Pathways, Building entrances, Corridors, etc.

Area	Existing lamp		Proposed lamp		Power savings	
Industry	GLS	13w	CFL	9w	4 w	31%
	GLS	200w	Blended	160w	40w	20%
Domestic	GLS	60w	CFL	25w	35w	58%



**c) Replacing conventional fluorescent lamp by energy efficient fluorescent lamp:** Energy efficient lamps are based on the highly sophisticated technology. They offer excellent colour rendering properties in addition to the very high luminous efficacy.

Area	Lamp Type				Power Saving	
	Existing		Proposed		Watts	Efficiency
Industry	TL	40w	TLD	36w	4w	10%
Street lighting	TL	2*40 w	TL	2*36 w	08w	06
Domestic	TL	40w	T-8	28w	12w	30

**d) Replacement of Mercury/Sodium Vapor Lamp by Halides Lamp:** MHL provides high colour rendering index and offer efficient white light. Hence for critical applications where higher illumination levels are required, these lamps are used. They are highly suitable for applications such as assembly line, inspection area, painting shops etc.

Area	Existing lamp	Proposed lamp	Power savings	
Industry	HPMV- 400w	MHL- 250w	5 w	17%
Commercial	HPSV- 150w	MHL- 250w	150w	35%
Street lighting	GLS - 200w	ML- 160w	40 w	07%
	GL- 300w	ML- 250w	50 w	17%

**e) Replacing HPMV Lamps by High pressure sodium Vapour Lamp (HPSV):** Where colour rendering is not critical for such applications e g street lighting, yard lighting because CRI of HPSV is low but offer more efficiency.

Area	Existing lamp	Proposed lamp	Power savings	
Street lighting	HPMV - 125w	HPSV 70w	25 w	44%
	HPMV- 250w	HPSV 150w	100 w	40%
Yard lighting	HPMV- 250w	HPSV 150w	100 w	40 %

**f) Replacing filament lamps on panels by LED:** LED lamps consumes less power (1 W lamp), withstand high voltage fluctuation in the power supply, longer operating life (>100,000 hrs). Hence nowadays they are also used in street lighting, signaling, advertising boards, even as replacement for tube light or CFL.

**g) Replacement of conventional ballast by Electronic ballast:** Installation of high frequency (28 – 32Mhz) electronic ballast in place of conventional ballasts helps to reduce power consumption up to 35%.

**h) Installation of separate transformer for lighting:** In most of the industries, the net lighting load varies between 2 to 10%. If power load and lighting load fed by same transformer, switching operation and load variation causes voltage fluctuations. This also affects the performance of neighboring power load apparatus, lighting load equipments and also reduces lamps. Hence, the lighting equipment has to be isolated from the power feeders. This will reduce the voltage related problems, which in turn provides a better voltage regulation for the lighting This also increases the efficiency of the lighting system.

**i) Installation of servo stabilizer for lighting feeder:** Wherever, installation of separate transformer for lighting is not economically attractive and then servo stabilizer can be installed for the lighting feeders.

**j) Control over energy consumption pattern:** Occupancy Sensors, Daylight Linked Control are commonly used in commercial buildings, malls, offices, where more no. Of lights are to be controlled as per operational hours microprocessor based Light control circuits are used. As a single control unit it can be programmed to switch on /off as per the month wise, year wise and even season wise working schedule.

**k) Periodic survey and adequate maintenance program:** Illumination level reduces due to accumulation of dirt on lamps and luminaries. By carrying periodic maintenance i.e. cleaning, dusting of lamps and luminaries will improve the light output / luminance. As part of maintenance programme, periodic surveys of installation, lightning system with respect lamp positioning and illumination levels, proper operation of control gears should be conducted to take advantage of energy conservation opportunities as user requirements changes.

#### **1.4.7 Energy Conservation in Motors:**

Considering all industrial applications 70% of total electrical energy consumed by only electric motors driven equipments.

**a. Improving power supply quality:** Maintaining the voltage level within the BIS standards i.e. with tolerance of +/-6% and frequency with tolerance of +/-3% motor performance improves and also life.

**b. Optimum loading:** Proper selection of the rating of the motor will reduce the power consumption. If the motor is operating at less than 50% of loading (<50%) significant power saving can be obtained by replacing with properly sized high efficiency motors. If the motor is operating at loads below 40% of its capacity, an inexpensive and effective measure might be to operate in star mode.

**c. Improving transmission efficiency:** Proper selection of power transmission means (belts, gears) will reduce transmission losses.

**d.** Stopping idle or redundant running of motors or lights will save 100% power.

**e. By use of Soft Starter:** Soft starters are essentially stator voltage controllers; helps to overcome above problem. It helps to **restrict starting current** and also provide **smooth start and stop operation**.



Application	No. Of working hours	No. Of jobs	Energy consumed in kWh	Savings in kWh	Savings in %
<b>Grinding machine</b>					
Without soft starter	7	55	168.0	---	---
With soft starter	7	51	136.8	31.2	18.6
<b>Lathe machine (5.5 kW)</b>					
Without soft starter	7	231	96.4	---	---
With soft starter	7	228	76.4	19.6	20.4

**f. By improving power factor:** For improving p.f., connect the capacitor bank, which will improve the p.f. of the system from installation to generating station. Maximum improvement in overall system efficiency is achieved, which also reduces max. demand of the system and that will reflect in energy bill.

**g. Use of high efficiency or Energy efficient motors:** The energy efficient motors have reduced losses through improved design, better materials and improved manufacturing techniques. Generally motor life doubles for each 10<sup>0</sup> C reduction in operating temperature. While selecting EEM, select with 1.15 service factor, design for operation at 85% of rated load.

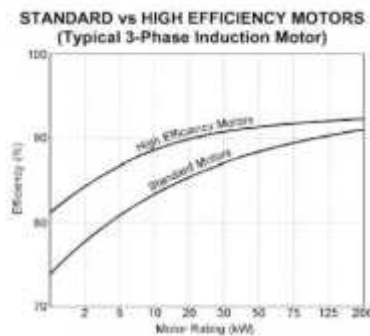

## 1.5 Energy economics- discount rate, payback period, internal rate of return, net present value, and life cycle cost.

In most respects, investment in energy efficiency is no different from any other area of financial management. So when your organization first decides to invest in increasing its energy efficiency it should apply exactly the same criteria to reducing its energy consumption as it applies to all its other investments. It should not require a faster or slower rate of return on investment in energy efficiency than it demands elsewhere.

### Discount rate

The discount rate is the interest rate that firms use to determine how much a future cash flow is worth in the present. The practice of using the discount rate to evaluate cash flows is called discounting

Using the discount rate, the calculation finds the **present value**:

$$\text{Present value} = \frac{\text{Future Value After } t \text{ Periods}}{(1+r)^t}$$

- $t$  = Period of time measured in years
- $r$  = The discount rate (interest rate) expressed as a decimal
- The future value after the whole period of time ( $t$ )

If the future value after one year is \$10,500 and the discount rate is 5% then:

$$\text{Present value} = \frac{10,500}{(1.05)^1}$$

**Present value = \$10,000**

If a consumer wants to save their money to earn interest so they can buy a new TV in 2 years, then they can use the price of the TV (\$2,500, assuming it does not change) and find out how much money they need to save at 7% interest:

$$\text{Present value} = \frac{2,500}{(1.07)^2}$$

**Present value = \$2,183.59**

If they put \$2,183.59 away at 7% interest over 2 years then they will have the right amount of money to buy the TV they want.

### **Simple Payback Period**

This is the simplest technique that can be used to appraise a proposal. The simple payback period can be defined as 'the length of time required for the running total of net savings before depreciation to equal the capital cost of the project'. In theory, once the payback period has ended, all the project capital costs will have been recouped and any additional cost savings achieved can be seen as clear 'profit'. Obviously, the shorter the payback period, the more attractive the project becomes. The length of the maximum permissible payback period generally varies with the business culture concerned. In some companies, payback periods in excess of 3 years are considered acceptable.

The payback period can be calculated using the equation

$$\text{Simple payback period (years)} = \frac{\text{Capital cost of the project (in Rs.)}}{\text{Net Annual savings (in Rs.)}}$$

$$\text{PB} = \frac{\text{CC}}{\text{AS}}$$

Where PB is the payback period (years), CC is the capital cost of the project (Rs.), and AS is the annual net cost saving achieved (Rs.).

The annual net cost saving (AS) is the least savings achieved after all the operational costs have been met. Simple payback period is illustrated in Example 4.

#### Example 4

A new small cogeneration plant installation is expected to reduce a company's annual energy bill by Rs.4,86,000. If the capital cost of the new boiler installation is Rs.22,20,000 and the annual maintenance and operating costs are Rs. 42,000, the expected payback period for the project can be worked out as.

#### Solution

$$\text{PB} = 22,20,000 / (4,86,000 - 42,000) = 5.0 \text{ years}$$

The payback method is a simple technique, which can easily be used to provide a quick evaluation of a proposal. However, it has a number of major weaknesses:

- The payback method does not consider savings that are accrued after the payback period has finished.
- The payback method does not consider the fact that money, which is invested, should accrue interest as time passes. In simple terms there is a 'time value' component to cash flows. Thus Rs.1000 today is more valuable than Rs.1000 in 10 years' time.

In order to overcome these weaknesses a number of discounted cash flow techniques have been developed, which are based on the fact that money invested in a bank will accrue annual interest. The two most commonly used techniques are the 'net present value' and the 'internal rate of return' methods.

**The simple payback period is usually calculated as follows:**

$$\text{Simple payback period} = \frac{\text{First cost}}{\text{Yearly benefits} - \text{yearly costs}}$$

#### Examples

Simple payback period for a continuous Deodorizer that costs Rs.60 lakhs to purchase and install, Rs.1.5 lakhs per year on an average to operate and maintain and is expected to save

Rs. 20 lakhs by reducing steam consumption (as compared to batch deodorizers), may be calculated as follows: According to the payback criterion, the shorter the payback period, the more desirable the project.

$$\text{Simple payback period} = \frac{60}{20 - 1.5} = 3 \text{ years } 3 \text{ months}$$

### Internal rate of return method

It can be seen from Example 5 that both projects returned a positive net present value over 10 years, at a discount rate of 8%. However, if the discount rate were reduced there would come a point when the net present value would become zero. It is clear that the discount rate which must be applied, in order to achieve a net present value of zero, will be higher for Project 2 than for Project 1. This means that the average rate of return for Project 2 is higher than for Project 1, with the result that Project 2 is the better proposition.

The discount rate which achieves a net present value of zero is known as the internal rate of return (IRR). The higher the internal rate of return, the more attractive the project.

Example 6 illustrates how an internal rate of return analysis is performed.

#### Example 6

A proposed project requires an initial capital investment of Rs.20 000. The cash flows generated by the project are shown in the table below:

Year	Cash flow (Rs.)
0	-20,000.00
1	+6000.00
2	+5500.00
3	+5000.00
4	+4500.00
5	+4000.00
6	+4000.00

Given the above cash flow data, let us find out the internal rate of return for the project.

## Solution

	Cash flow (Rs.) (Rs.)	8% discount rate		12% discount rate		16% discount rate	
		Discount factor	Present value (Rs.)	Discount factor	Present value	Discount factor (Rs.)	Present value
0	-20000	1.000	-20000	1.000	-20000	1.000	-20000
1	6000	0.926	5556	0.893	5358	0.862	5172
2	5500	0.857	4713.5	0.797	4383.5	0.743	4086.5
3	5000	0.794	3970	0.712	3560	0.641	3205
4	4500	0.735	3307.5	0.636	3862	0.552	2484
5	4000	0.681	2724	0.567	2268	0.476	1904
6	4000	0.630	2520	0.507	2028	0.410	1640
		NPV = 2791		NPV = 459.5		NPV = -1508.5	

It can clearly be seen that the discount rate which results in the net present value being zero lies somewhere between 12% and 16%. For 12% discount rate, NPV is positive; for 16% discount rate, NPV is negative. Thus for some discount rate between 12 and 16 percent, present value benefits are equated to present value costs. To find the value exactly, one can interpolate between the two rates as follows:

$$\text{Internal rate of return} = 0.12 + (0.16 - 0.12) \times \frac{459.5}{(459.5 - (-1508.5))} \times 100$$

$$\text{Internal rate of return} = 0.12 + (0.16 - 0.12) \times \frac{459.5}{(459.5 + 1508.5)} \times 100 = 12.93\%$$

Thus the internal rate of return for the project is 12.93%. At first sight both the net present value and internal rate of return methods look very similar, and in some respects are. Yet there is an important difference between the two. The net present value method is essentially a comparison tool, which enables a number of projects to be compared, while the internal rate of return method is designed to assess whether or not a single project will achieve a target rate of return.

### Net Present Value Method

The net present value method considers the fact that a cash saving (often referred to as a 'cash flow') of Rs.1000 in year 10 of a project will be worth less than a cash flow of Rs.1000 in year 2. The net present value method achieves this by quantifying the impact of time on any particular future cash flow. This is done by equating each future cash flow to its current value today, in other words determining the present value of any future cash flow. The present value (PV) is determined by using an assumed interest rate, usually referred to as a discount rate. Discounting is the opposite process to compounding. Compounding determines the future

value of present cash flows, where" discounting determines the present value of future cash flows.

In order to understand the concept of present value, consider the case described in Example 3. If instead of installing a new cogeneration system, the company invested Rs.22,20,000 in a bank at an annual interest rate of 8%, then:

The value of the sum at the end of year 1 =  $22,20,000 + (0.08 \times 22,20,000) = \text{Rs.}23,97,600$

The value of the sum at the end of year 2 =  $23,97,600 + (0.08 \times 23,97,600) = \text{Rs.}25,89,408$

The value of the investment would grow as compound interest is added, until after n years the value of the sum would be:

$$FV = D \times (1 + IR/100)^n$$

Where FV is the future value of investment in Rs., and D is the value of initial deposit (or investment) in Rs., IR is Interest Rate and n is number of years.

**Example :**

The future value of the investment made at present, after 5 years will be:

$$FV = 22,20,000 \times (1 + 8/100)^5 = \text{Rs.}32,61,908.4$$

So in 5 years the initial investment of 22,20,000 will accrue Rs.10,41,908.4 in interest and will be worth Rs.32,61,908.4. Alternatively, it could equally be said that Rs.32,61,908.4 in 5 years time is worth Rs.22,20,000 now (assuming an annual interest rate of 8%). In other words the *present value* of Rs.32,61,908.40 in 5 years time is Rs.22,00,000 now.

The *present value* of an amount of money at any specified time in the future can be determined by the following equation.



$$PV = S \times (1 + IR/100)^{-n}$$

Where PV is the present value of S in n years time (Rs.), and S is the value of cash flow in n years time (Rs.).

The net *present value* method calculates the *present value* of all the yearly cash flows (i.e. capital costs and net savings) incurred or accrued throughout the life of a project, and summates them. Costs are represented as a negative value and savings as a positive value. The sum of all the present values is known as the *net present value* (NPV). The higher the *net present value*, the more attractive the proposed project.

The *present value* of a future cash flow can be determined using the equation above. However, it is common practice to use a *discount factor* (DF) when calculating present value. The discount factor is based on an assumed discount rate (i.e. interest rate) and can be determined by using equation.

$$DF = (1 + IR/100)^{-n}$$

The product of a particular cash flow and the discount factor is the present value.

$$PV = S \times DF$$

The values of various discount factors computed for a range of discount rates (i.e. interest rates) are shown in Table 11.1. The Example 5 illustrates the process involved in a net present value analysis.

TABLE 11.1 COMPUTED DISCOUNT FACTORS								
Discount rate % (or interest rate %)								
Year	2	4	6	8	10	12	14	16
0	1.000	1.000	1.000	1.000	1.000	1.000	1.000	1.000
1	0.980	0.962	0.943	0.926	0.909	0.893	0.877	0.862
2	0.961	0.825	0.890	0.857	0.826	0.797	0.769	0.743
3	0.942	0.889	0.840	0.794	0.751	0.712	0.675	0.641
4	0.924	0.855	0.792	0.735	0.683	0.636	0.592	0.552
5	0.906	0.822	0.747	0.681	0.621	0.567	0.519	0.476
6	0.888	0.790	0.705	0.630	0.564	0.507	0.456	0.410
7	0.871	0.760	0.665	0.583	0.513	0.452	0.400	0.354
8	0.853	0.731	0.627	0.540	0.467	0.404	0.351	0.305
9	0.837	0.703	0.592	0.500	0.424	0.361	0.308	0.263
10	0.820	0.676	0.558	0.463	0.386	0.322	0.270	0.227
11	0.804	0.650	0.527	0.429	0.350	0.287	0.237	0.195
12	0.788	0.625	0.497	0.397	0.319	0.257	0.208	0.168
13	0.773	0.601	0.469	0.368	0.290	0.229	0.182	0.145
14	0.758	0.577	0.442	0.340	0.263	0.205	0.160	0.125
15	0.743	0.555	0.417	0.315	0.239	0.183	0.140	0.108
16	0.728	0.534	0.394	0.292	0.218	0.163	0.123	0.093
17	0.714	0.513	0.371	0.270	0.198	0.146	0.108	0.080
18	0.700	0.494	0.350	0.250	0.180	0.130	0.095	0.069
19	0.686	0.475	0.331	0.232	0.164	0.116	0.083	0.060
20	0.673	0.456	0.312	0.215	0.149	0.104	0.073	0.051

### Life cycle cost

Life cycle costing, or whole-life costing, is the process of estimating how much money you will spend on an asset over the course of its useful life. Whole-life costing covers an asset's costs from the time you purchase it to the time you get rid of it.

Buying an asset is a cost commitment that extends beyond its price tag. For example, think of a car. The car's price tag is only part of the car's overall life cycle cost. You also need to consider expenses for car insurance, interest, gas, oil changes, and any other necessary maintenance to keep the car running. Not planning for these additional costs can set you back.

The cost to buy, use, and maintain a business asset adds up. Whether you're purchasing a car, a copier, a computer, or inventory, you should consider and budget for the asset's future costs.



## Life cycle costing process

Conducting a life cycle cost assessment helps you better predict how much your business will pay when you acquire a new asset.

To calculate an asset's life cycle cost, estimate the following expenses:

1. Purchase
2. Installation
3. Operating
4. Maintenance
5. Financing (e.g., interest)
6. Depreciation
7. Disposal

Add up the expenses for each stage of the life cycle to find your total.

You might use past data to help you create a more accurate cost prediction. To simplify the process, start with your fixed costs. Fixed costs for businesses are the expenses that stay the same from month to month. Then, estimate variable costs, which are expenses that change.

### Life cycle costing process for intangible assets

You can also use life cycle costing to determine how much your intangible assets will cost. Intangible assets are non-physical property, such as patents, your business's brand, and your reputation.

Although it is more difficult to add up the whole-life cost of an intangible asset than a tangible asset (physical property), it's still possible. Consider the total cost of acquiring and maintaining an intangible asset.

For example, patents cost thousands of dollars. You might also need to hire a lawyer to help you obtain one. And, you will need to pay fees to maintain your patent.

Or, consider your business's brand. You might spend money on all the things that go into creating your brand, such as developing a logo, registering your name, and setting up a small business website. Further, you will spend money on marketing and maintaining your brand.

### Life cycle costing assessment example

Let's say you want to buy a new copier for your business.

**Purchase:** The purchase price is \$2,500.

**Installation:** You spend an additional \$75 for setup and delivery.

**Operating:** You need to buy ink cartridges and paper for it, so you estimate you will spend \$1,000 on these supplies over the course of its useful life. And, you expect the total electricity the copier will use to be \$300.

**Maintenance:** If the copier breaks, you estimate repairs will total \$450.

**Financing:** You purchase the copier with your store credit card, which has an interest rate of 3.5% per month. You pay off the printer the next month, meaning you owe \$87.50 in interest ( $\$2,500 \times 3.5\%$ ).

**Depreciation:** You predict the copier will lose value by \$150 each year.

**Disposal:** You estimate it will cost \$100 to hire an independent contractor to remove the copier from your business.

Although the purchase price of the copier is \$2,500, the life cycle cost of the copier could end up costing your business over \$4,500.

### **Purpose of the life cycle cost analysis**

As mentioned, conducting a life cycle cost analysis helps you estimate how much an asset will cost you over the course of its life.

Take a look at some of the reasons why knowing an asset's total cost can guide your business decisions.

#### **1. Choose between two or more assets**

Using life cycle costing helps you make purchasing decisions. If you only factor in the initial cost of an asset, you could end up spending more in the long run. For example, buying a used asset might have a lower price tag, but it could cost you more in repairs and utility bills than a newer model.

Life cycle cost management depends on your ability to make a smart investment. When you are deciding between two or more assets, consider their overall costs, not just the price tag in front of you.

#### **2. Determine the asset's benefits**

How do you know if you should buy an asset? Generally, you weigh the pros and cons of your purchase. But if you only consider the initial, short-term cost, you won't know if the asset will benefit your business financially in the long run.

By using life cycle costing, you can more accurately predict if the asset's return on investment (ROI) is worth the expense. If you only look at the asset's current purchase cost and don't factor in future costs, you will overestimate the ROI.

#### **3. Create accurate budgets**

When you know how much an asset's total price is, you can create budgets that represent your business's actual expenses. That way, you won't underestimate your business's costs.

A budget is made up of expenses, revenue, and profits. If you underestimate an asset's cost on your budget, you are overestimating your profits. Failing to account for expenses can result in overspending and negative cash flow.

## **1.6 Energy generation, energy distribution, energy usage by processes, technical and economic evaluation**

### **Identification of Energy Conservation Opportunities**

**Fuel substitution:** Identifying the appropriate fuel for efficient energy conversion

**Energy generation:** Identifying Efficiency opportunities in energy conversion equipment/utility such as captive power generation, steam generation in boilers, thermic fluid heating, optimal loading of DG sets, minimum excess air combustion with boilers/thermic fluid heating, optimising existing efficiencies, efficient energy conversion equipment, biomass gasifiers, Cogeneration, high efficiency DG sets, etc.

**Energy distribution:** Identifying Efficiency opportunities network such as transformers, cables, switchgears and power factor improvement in electrical systems and chilled water, cooling water, hot water, compressed air, Etc.

**Energy usage by processes:** This is where the major opportunity for improvement and many of them are hidden. Process analysis is useful tool for process integration measures.

### Technical and Economic feasibility

The technical feasibility should address the following issues

- Technology availability, space, skilled manpower, reliability, service etc
- The impact of energy efficiency measure on safety, quality, production or process.
- The maintenance requirements and spares availability

The Economic viability often becomes the key parameter for the management acceptance. The economic analysis can be conducted by using a variety of methods. Example: Pay back method, Internal Rate of Return method, Net Present Value method etc. For low investment short duration measures, which have attractive economic viability, simplest of the methods, payback is usually sufficient. A sample worksheet for assessing economic feasibility is provided below:

Sample Worksheet for Economic Feasibility		
Name of Energy Efficiency Measure		
1. Investment	2. Annual operating costs	3. Annual savings
<ul style="list-style-type: none"> <li>a. Equipments</li> <li>b. Civil works</li> <li>c. Instrumentation</li> <li>d. Auxiliaries</li> </ul>	<ul style="list-style-type: none"> <li>• Cost of capital</li> <li>• Maintenance</li> <li>• Manpower</li> <li>• Energy</li> <li>• Depreciation</li> </ul>	<ul style="list-style-type: none"> <li>• Thermal Energy</li> <li>• Electrical Energy</li> <li>• Raw material</li> <li>• Waste disposal</li> </ul>
Net Savings /Year (Rs./year) = (Annual savings-annual operating costs)		Payback period in months = (Investment/net savings/year) x 12

## 1.7 Understanding Energy Costs:

Understanding energy cost is vital factor for awareness creation and saving calculation. In many industries sufficient meters may not be available to measure all the energy used. In such cases, invoices for fuels and electricity will be useful. The annual company balance sheet is the other sources where fuel cost and power are given with production related information.

**Energy invoices can be used for the following purposes:**

- They provide a record of energy purchased in a given year, which gives a base-line for future reference
- Energy invoices may indicate the potential for savings when related to production requirements or to air conditioning requirements/space heating etc.
- When electricity is purchased on the basis of maximum demand tariff
- They can suggest where savings are most likely to be made.
- In later years invoices can be used to quantify the energy and cost savings made through energy conservation measures

### **Fuel Costs**

A wide variety of fuels are available for thermal energy supply. Few are listed below:

- Fuel oil
- Low Sulphur Heavy Stock (LSHS)
- Light Diesel Oil (LDO)
- Liquefied Petroleum Gas (LPG)
- COAL
- LIGNITE
- WOOD ETC.

Understanding fuel cost is fairly simple and it is purchased in Tons or Kiloliters. Availability, cost and quality are the main three factors that should be considered while purchasing. The following factors should be taken into account during procurement of fuels for energy efficiency and economics.

- Price at source, transport charge, type of transport
- Quality of fuel (contaminations, moisture etc)
- Energy content (calorific value)

## Power Costs

Electricity price in India not only varies from State to State, but also city to city and consumer to consumer though it does the same work everywhere. Many factors are involved in deciding final cost of purchased electricity such as:

- Maximum demand charges, kVA (i.e. How fast the electricity is used? )
- Energy Charges, kWh (i.e., How much electricity is consumed? )
- TOD Charges, Peak/Non-peak period (i.e. When electricity is utilized ?)
- Power factor Charge, P.F (i.e., Real power use versus Apparent power use factor )
- Other incentives and penalties applied from time to time
- High tension tariff and low tension tariff rate changes
- Slab rate cost and its variation
- Type of tariff clause and rate for various categories such as commercial, residential, industrial, Government, agricultural, etc.
- Tariff rate for developed and underdeveloped area/States
- Tax holiday for new projects

### Example: Purchased energy Bill

A typical summary of energy purchased in an industry based on the invoices

TABLE 1.4			
Type of energy	Original units	Unit Cost	Monthly Bill Rs.
Electricity	5,00,000 kWh	Rs.4.00/kWh	20,00,000
Fuel oil	200 kL	Rs.10,000/ kL	20,00,000
Coal	1000 tons	Rs.2,000/ton	20,00,000
Total			60,00,000

Unfortunately the different forms of energy are sold in different units e.g. kWh of electricity, liters of fuel oil, tonne of coal. To allow comparison of energy quantities these must be converted to a common unit of energy such as kWh, Giga joules, kCals etc.

Electricity (1 kWh) = 860 kCal/kWh (0.0036 GJ)

Heavy fuel oil (Gross calorific value, GCV) =10000 kCal/litre ( 0.0411 GJ/litre)

Coal (Gross calorific value, GCV) =4000 kCal/kg ( 28 GJ/ton)

## 1.8 Classification of Energy Conservation Measures

Based on energy audit and analyses of the plant, a number of potential energy saving projects may be identified. These may be classified into three categories:

1. Low cost - high return;
2. Medium cost - medium return;
3. High cost - high return

Normally the low cost - high return projects receive priority. Other projects have to be analyzed, engineered and budgeted for implementation in a phased manner. Projects relating to energy cascading and process changes almost always involve high costs coupled with high returns, and may require careful scrutiny before funds can be committed. These projects are generally complex and may require long lead times before they can be implemented. Refer Table 3.1 for project priority guidelines.

TABLE 3.1 PROJECT PRIORITY GUIDELINE			
Priority	Economical Feasibility	Technical Feasibility	Risk / Feasibility
<b>A - Good</b>	Well defined and attractive	Existing technology adequate	No Risk/ Highly feasible
<b>B -May be</b>	Well defined and only marginally acceptable	Existing technology may be updated, lack of confirmation	Minor operating risk/May be feasible
<b>C -Held</b>	Poorly defined and marginally unacceptable	Existing technology is inadequate	Doubtful
<b>D -No</b>	Clearly not attractive	Need major breakthrough	Not feasible

## 1.9 Benchmarking and Energy Performance

Benchmarking of energy consumption internally (historical / trend analysis) and externally (across similar industries) are two powerful tools for performance assessment and logical evolution of avenues for improvement. Historical data well documented helps to bring out energy consumption and cost trends month-wise / day-wise. Trend analysis of energy consumption, cost, relevant production features, specific energy consumption, help to understand effects of capacity utilization on energy use efficiency and costs on a broader scale.

External benchmarking relates to inter-unit comparison across a group of similar units. However, it would be important to ascertain similarities, as otherwise findings can be grossly misleading. Few comparative factors, which need to be looked into while benchmarking externally are:

- Scale of operation
- Vintage of technology

- Raw material specifications and quality
- Product specifications and quality

Benchmarking energy performance permits

- Quantification of fixed and variable energy consumption trends vis-à-vis production levels
- Comparison of the industry energy performance with respect to various production levels (capacity utilization)
- Identification of best practices (based on the external benchmarking data)
- Scope and margin available for energy consumption and cost reduction
- Basis for monitoring and target setting exercises.

**The benchmark parameters can be:**

- **Gross production related**

e.g. kWh/MT clinker or cement produced (cement plant)

e.g. kWh/kg yarn produced (Textile unit)

e.g. kWh/MT, kCal/kg, paper produced (Paper plant)

e.g. kCal/kWh Power produced (Heat rate of a power plant)

e.g. Million kilocal/MT Urea or Ammonia (Fertilizer plant)

e.g. kWh/MT of liquid metal output (in a foundry)

- **Equipment / utility related**

e.g. kW/ton of refrigeration (on Air conditioning plant)

e.g. % thermal efficiency of a boiler plant

e.g. % cooling tower effectiveness in a cooling tower

e.g. kWh/NM<sup>3</sup> of compressed air generated

e.g. kWh /litre in a diesel power generation plant.

While such benchmarks are referred to, related crucial process parameters need mentioning for meaningful comparison among peers. For instance, in the above case:

- For a cement plant - type of cement, blaine number (fineness) i.e. Portland and process used (wet/dry) are to be reported alongside kWh/MT figure.
- For a textile unit - average count, type of yarn i.e. polyester/cotton, is to be reported alongside kWh/square meter.
- For a paper plant - paper type, raw material (recycling extent), GSM quality is some important factors to be reported along with kWh/MT, k Cal/Kg figures.

- For a power plant / cogeneration plant - plant % loading, condenser vacuum, inlet cooling water temperature, would be important factors to be mentioned alongside heat rate (kCal/kWh).
- For a fertilizer plant - capacity utilization(%) and on-stream factor are two inputs worth comparing while mentioning specific energy consumption
- For a foundry unit - melt output, furnace type, composition (mild steel, high carbon steel/cast iron etc.) raw material mix, number or power trips could be some useful operating parameters to be reported while mentioning specific energy consumption data.
- For an Air conditioning (A/c) plant - Chilled water temperature level and refrigeration load (TR) are crucial for comparing kW/TR.
- For a boiler plant - fuel quality, type, steam pressure, temperature, flow, are useful comparators alongside thermal efficiency and more importantly, whether thermal efficiency is on gross calorific value basis or net calorific value basis or whether the computation is by direct method or indirect heat loss method, may mean a lot in benchmarking exercise for meaningful comparison.
- Cooling tower effectiveness - ambient air wet/dry bulb temperature, relative humidity, air and circulating water flows are required to be reported to make meaningful sense.
- Compressed air specific power consumption - is to be compared at similar inlet air temperature and pressure of generation.
- Diesel power plant performance - is to be compared at similar loading %, steady run condition etc.

## 1.10 Plant Energy Performance

Plant energy performance (PEP) is the measure of whether a plant is now using more or less energy to manufacture its products than it did in the past: a measure of how well the energy management programme is doing. It compares the change in energy consumption from one year to the other considering production output. Plant energy performance monitoring compares plant energy use at a reference year with the subsequent years to determine the improvement that has been made.

However, a plant production output may vary from year to year and the output has a significant bearing on plant energy use. For a meaningful comparison, it is necessary to determine the energy that would have been required to produce this year production output, if the plant had operated in the same way as it did during the reference year. This calculated value can then be compared with the actual value to determine the improvement or deterioration that has taken place since the reference year.

### Production factor

Production factor is used to determine the energy that would have been required to produce this year's production output if the plant had operated in the same way as it did in the reference year. It is the ratio of production in the current year to that in the reference year.



$$\text{Production factor} = \frac{\text{Current year's production}}{\text{Reference year's production}}$$

### Reference Year Equivalent Energy Use

The reference year's energy use that would have been used to produce the current year's production output may be called the "reference year energy use equivalent" or "reference year equivalent" for short. The reference year equivalent is obtained by multiplying the reference year energy use by the production factor (obtained above)

Reference year equivalent = Reference year energy use x Production factor

The improvement or deterioration from the reference year is called "energy performance" and is a measure of the plant's energy management progress. It is the reduction or increase in the current year's energy use over the reference, and is calculated by subtracting the current year's energy use from the reference years equivalent. The result is divided by the reference year equivalent and multiplied by 100 to obtain a percentage

$$\text{Plant energy performance} = \frac{\text{Reference year equivalent} - \text{Current year's energy}}{\text{Reference year equivalent}} \times 100$$

The energy performance is the percentage of energy saved at the current rate of use compared to the reference year rate of use. The greater the improvement, the higher the number will be.

### Monthly Energy Performance

Experience however, has shown that once a plant has started measuring yearly energy performance, management wants more frequent performance information in order to monitor and control energy use on an on-going basis. PEP can just as easily be used for monthly reporting as yearly reporting.

## 1.11 Matching Energy Usage to Requirement

Mismatch between equipment capacity and user requirement often leads to inefficiencies due to part load operations, wastages etc. Worst case design, is a designer's characteristic, while optimization is the energy manager's mandate and many situations present themselves towards an exercise involving graceful matching of energy equipment capacity to end-use needs. Some examples being:

- Eliminate throttling of a pump by impeller trimming, resizing pump, installing variable speed drives
- Eliminate damper operations in fans by impeller trimming, installing variable speed drives, pulley diameter modification for belt drives, fan resizing for better efficiency.
- Moderation of chilled water temperature for process chilling needs
- Recovery of energy lost in control valve pressure drops by back pressure/turbine adoption

- Adoption of task lighting in place of less effective area lighting

## 1.12 Maximising System Efficiency

Once the energy usage and sources are matched properly, the next step is to operate the equipment efficiently through best practices in operation and maintenance as well as judicious technology adoption. Some illustrations in this context are:

- Eliminate steam leakages by trap improvements
- Maximise condensate recovery
- Adopt combustion controls for maximizing combustion efficiency
- Replace pumps, fans, air compressors, refrigeration compressors, boilers, furnaces, heaters and other energy consuming equipment, wherever significant energy efficiency margins exist.

### Optimising the Input Energy Requirements

Consequent upon fine-tuning the energy use practices, attention is accorded to considerations for minimizing energy input requirements. The range of measures could include:

- Shuffling of compressors to match needs.
- Periodic review of insulation thickness
- Identify potential for heat exchanger networking and process integration.
- Optimisation of transformer operation with respect to load.

## 1.13 Fuel and Energy Substitution

**Fuel substitution:** Substituting existing fossil fuel with more efficient and less cost/less polluting fuel such as natural gas, biogas and locally available agro-residues.

Energy is an important input in the production. There are two ways to reduce energy dependency; energy conservation and substitution.

Fuel substitution has taken place in all the major sectors of the Indian economy. Kerosene and Liquefied Petroleum Gas (LPG) have substituted soft coke in residential use. Few examples of fuel substitution

- Natural gas is increasingly the fuel of choice as fuel and feedstock in the fertilizer, petrochemicals, power and sponge iron industries.
- Replacement of coal by coconut shells, rice husk etc.
- Replacement of LDO by LSHS

Few examples of energy substitution

- Replacement of electric heaters by steam heaters
- Replacement of steam based hotwater by solar systems

### Case Study : Example on Fuel Substitution

A textile process industry replaced old fuel oil fired thermic fluid heater with agro fuel fired heater. The economics of the project are given below:

<b>A:</b>	<b>Title of Recommendation :</b>	<b>Use of Agro Fuel (coconut chips) in place of Furnace oil in a Boiler</b>
<b>B:</b>	<b>Description of Existing System and its operation :</b>	A thermic fluid heater with furnace oil currently. In the same plant a coconut chip fired boiler is operating continuously with good performance.
<b>C:</b>	<b>Description of Proposed system and its operation :</b>	It was suggested to replace the oil fired thermic fluid heater with coconut chip fired boiler as the company has the facilities for handling coconut chip fired system
<b>D:</b>	<b>Energy Saving Calculations</b>	
<b>Old System</b>		
	Type of fuel Firing GCV Avg. Thermal Efficiency Heat Duty Operating Hours  Annual Fuel Cost	: Furnace Oil fired heater : 10,200 kCal/kg : 82% : 15 lakh kCal / hour : 25 days x 12 month x 24 hours = 7,200 hrs. : Rs.130 lakh (7200 x 1800 Rs./hr.)
<b>Modified System</b>		
	Type of fuel saving GCV Average Thermal Efficiency Heat Duty Annual Operating Cost Annual Savings Additional Auxiliary Power + Manpower Cost Net Annual Saving Investment for New Coconut Fired heater  Simple pay back period	= Coconut chips fired Heater = 4200 kCal/kg = 72 % = 15 lakh kCal / hour = 7200 x 700 Rs./hr = 50 lakh = 130 - 50 = Rs.80 lakh . = Rs. 10 lakh = Rs. 70 lakh = Rs. 35 lakh  = 6 months

## 1.14 Energy balancing.

Energy takes many forms, such as heat, kinetic energy, chemical energy, potential energy but because of interconversions it is not always easy to isolate separate constituents of energy balances. However, under some circumstances certain aspects predominate. In many heat balances in which other forms of energy are insignificant; in some chemical situations mechanical energy is insignificant and in some mechanical energy situations, as in the flow of fluids in pipes, the frictional losses appear as heat but the details of the heating need not be considered. We are seldom concerned with internal energies.

Therefore practical applications of energy balances tend to focus on particular dominant aspects and so a heat balance, for example, can be a useful description of important cost and quality aspects of process situation. When unfamiliar with the relative magnitudes of the various forms of energy entering into a particular processing situation, it is wise to put them all down. Then after some preliminary calculations, the important ones emerge and other minor ones can be lumped together or even ignored without introducing substantial errors. With experience, the obviously minor ones can perhaps be left out completely though this always raises the possibility of error.

Energy balances can be calculated on the basis of external energy used per kilogram of product, or raw material processed, or on dry solids or some key component. The energy consumed in food production includes direct energy which is fuel and electricity used on the farm, and in transport and in factories, and in storage, selling, etc.; and indirect energy which is used to actually build the machines, to make the packaging, to produce the electricity and the oil and so on. Food itself is a major energy source, and energy balances can be determined for animal or human feeding; food energy input can be balanced against outputs in heat and mechanical energy and chemical synthesis.

In the SI system there is only one energy unit, the joule. However, kilocalories are still used by some nutritionists and British thermal units (Btu) in some heat-balance work.

The two applications used in this chapter are heat balances, which are the basis for heat transfer, and the energy balances used in analysing fluid flow.

### **Heat Balances**

The most common important energy form is heat energy and the conservation of this can be illustrated by considering operations such as heating and drying. In these, enthalpy (total heat) is conserved and as with the mass balances so enthalpy balances can be written round the various items of equipment, or process stages, or round the whole plant, and it is assumed that no appreciable heat is converted to other forms of energy such as work.

Enthalpy (H) is always referred to some reference level or datum, so that the quantities are relative to this datum. Working out energy balances is then just a matter of considering the various quantities of materials involved, their specific heats, and their changes in temperature or state (as quite frequently latent heats arising from phase changes are encountered). Figure 4.3 illustrates the heat balance.

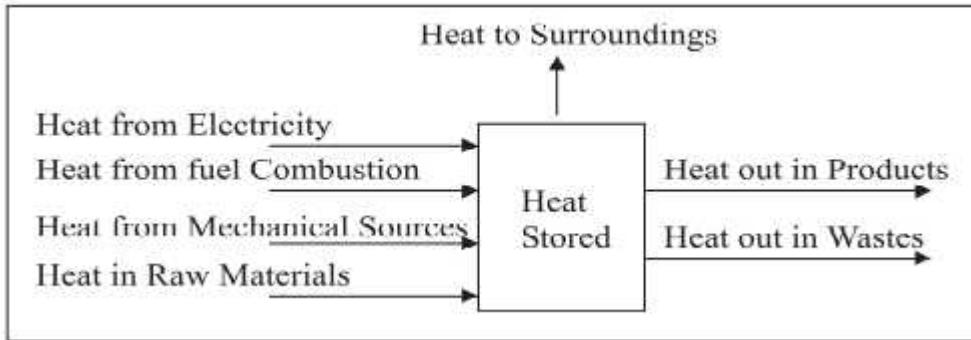

Heat is absorbed or evolved by some reactions in processing but usually the quantities are small when compared with the other forms of energy entering into food processing such as sensible heat and latent heat. Latent heat is the heat required to change, at constant temperature, the physical state of materials from solid to liquid, liquid to gas, or solid to gas. Sensible heat is that heat which when added or subtracted from materials changes their temperature and thus can be sensed. The units of specific heat are J/kg K and sensible heat change is calculated by multiplying the mass by the specific heat by the change in temperature, ( $m \times c \times \Delta T$ ). The units of latent heat are J/kg and total latent heat change is calculated by multiplying the mass of the material, which changes its phase by the latent heat. Having determined those factors that are significant in the overall energy balance, the simplified heat balance can then be used with confidence in industrial energy studies. Such calculations can be quite simple and straightforward but they give a quantitative feeling for the situation and can be of great use in design of equipment and process.

### Example: Dryer heat balance

A textile dryer is found to consume 4 m<sup>3</sup> /hr of natural gas with a calorific value of 800 kJ/mole. If the throughput of the dryer is 60 kg of wet cloth per hour, drying it from 55% moisture to 10% moisture, estimate the overall thermal efficiency of the dryer taking into account the latent heat of evaporation only

60 kg of wet cloth contains

$$60 \times 0.55 \text{ kg water} = 33 \text{ kg moisture}$$

$$\text{and } 60 \times (1-0.55) = 27 \text{ kg bone dry cloth.}$$

As the final product contains 10% moisture, the moisture in the product is  $27/9 = 3 \text{ kg}$

$$\text{And so Moisture removed / hr} = 33 - 3 = 30 \text{ kg/hr}$$

$$\text{Latent heat of evaporation} = 2257 \text{ kJ/K}$$

$$\text{Heat necessary to supply} = 30 \times 2257 = 6.8 \times 10^4 \text{ kJ/hr}$$

Assuming the natural gas to be at standard temperature and pressure at which 1 mole occupies 22.4 litres

$$\text{Rate of flow of natural gas} = 4 \text{ m}^3 \text{ /hr} = (4 \times 1000)/22.4 = 179 \text{ moles/hr}$$

$$\text{Heat available from combustion} = 179 \times 800 = 14.3 \times 10^4 \text{ kJ/hr}$$

Approximate thermal efficiency of dryer = heat needed / heat used =  $6.8 \times 10^4 / 14.3 \times 10^4 = 48\%$

To evaluate this efficiency more completely it would be necessary to take into account the sensible heat of the dry cloth and the moisture, and the changes in temperature and humidity of the combustion air, which would be combined with the natural gas. However, as the latent heat of evaporation is the dominant term the above calculation gives a quick estimate and shows how a simple energy balance can give useful information.

Similarly energy balances can be carried out over thermal processing operations, and indeed any processing operations in which heat or other forms of energy are used.

Example: Autoclave heat balance in canning

An autoclave contains 1000 cans of pea soup. It is heated to an overall temperature of  $100^\circ\text{C}$ . If the cans are to be cooled to  $40^\circ\text{C}$  before leaving the autoclave, how much cooling water is required if it enters at  $15^\circ\text{C}$  and leaves at  $35^\circ\text{C}$ ?

The specific heats of the pea soup and the can metal are respectively  $4.1 \text{ kJ/kg}^\circ\text{C}$  and  $0.50 \text{ kJ/kg}^\circ\text{C}$ . The weight of each can is 60g and it contains 0.45 kg of pea soup. Assume that the heat content of the autoclave walls above  $40^\circ\text{C}$  is  $1.6 \times 10^4 \text{ kJ}$  and that there is no heat loss through the walls.

Let  $w$  = the weight of cooling water required; and the datum temperature be  $40^\circ\text{C}$ , the temperature of the cans leaving the autoclave.

### Heat entering

Heat in cans = weight of cans x specific heat x temperature above datum =  $1000 \times 0.06 \times 0.50 \times (100-40) \text{ kJ} = 1.8 \times 10^3 \text{ kJ}$

Heat in can contents = weight pea soup x specific heat x temperature above datum =  $1000 \times 0.45 \times 4.1 \times (100 - 40) = 1.1 \times 10^5 \text{ kJ}$

Heat in water = weight of water x specific heat x temperature above datum =  $w \times 4.186 \times (15-40) = -104.6 w \text{ kJ}$ .

### Heat leaving

Heat in cans =  $1000 \times 0.06 \times 0.50 \times (40-40)$  (cans leave at datum temperature) = 0

Heat in can contents =  $1000 \times 0.45 \times 4.1 \times (40-40) = 0$

Heat in water =  $w \times 4.186 \times (35-40) = -20.9 w$

HEAT-ENERGY BALANCE OF COOLING PROCESS; 40°C AS DATUM LINE

	Heat Entering (kJ)	Heat Leaving (kJ)
Heat in cans	1800	Heat in cans 0
Heat in can contents	11000	Heat in can contents 0
Heat in autoclave wall	16000	Heat in autoclave wall 0
Heat in water	-104.6 w	Heat in water -20.9 W
Total heat entering	127.800 – 104.6 w	Total heat leaving -20.9 W
	Total heat entering –	Total heat leaving
	127800 – 104.6 w =	-20.9 w
	w =	1527 kg

Amount of cooling water required = 1527 kg.

## 1.15 Electricity Tariff

The electrical energy that is produced in a power station is delivered to a large number of consumers. The consumers can be convinced to use electrical energy if it is sold at a reasonable price. Here comes the idea of tariffs.

**Definition:** A tariff is the schedule of rates structured by the supplier for supplying electrical energy to various types of consumers. The rate at which electric energy is supplied to a consumer is known as a tariff.

**The following elements are engaged into account to determine the tariff:**

- Types of load (domestic, commercial, industrial)
- Maximum demand
- Time at which load is required
- The power factor of the load
- Amount of energy used

The way in which consumers pay for electrical energy changes according to their demands. Industrial consumers consume more energy for the relatively longer period than domestic consumers.

Tariffs should be framed in such a way so that it covers the cost of production, cost of supply, and yet yields some reasonable profit.

The price of energy supplied by a generating station depends on the established capacity of the plant and kWh generated. Maximum demand increases the installed capacity of the generating station.

The instant at which maximum demand occurs is too important in plant economics. If the maximum demand of the consumer and the maximum demand on the system take place simultaneously, additional plant capacity is needed.

However, if the maximum demand of the consumer occurs during off-peak hours, then we just need to improve the load factor and no extra plant capacity is needed. Thus, the overall cost per kWh generated is reduced.

**Power factor** is likewise an important factor from the point of view of plant economics.

At a low-power-factor, the load current is very high. Therefore, the current to be supplied from the generating station is also large. This high current is also responsible for large  $I^2R$  losses in the system and larger voltage drops. Therefore, the regulation becomes poor; in order to supply the consumer's voltage within permissible limits, power factor correction equipment is to be set up. Therefore, the cost of generation increases.

The cost of electrical energy is reduced by using a large amount of energy for a longer period.



**Table 1: Consumers and Their Tariffs**

<b>Consumers</b>	<b>Examples</b>	<b>Supply Given</b>	<b>Demand Factor</b>	<b>Tariff</b>
<b>Domestic</b>	Residential load, light, fan, television, radio, electric irons, domestic pumps, coolers, air conditioners	1 : supply up to a load of 5 kW	Small consumers (high unity), big consumers (0.5)	1. Simple
		3 : supply for loads exceeding 5 kW		2. Flat rate
				3. Block rate
<b>Commercial</b>	Shops, business houses, hotels, cinemas, clubs, etc.	1 : supply up to a load of 5 kW	Fairly high	1. Simple
		3 : supply for loads exceeding 5 kW		2. Flat rate
				3. Block rate
<b>Agricultural</b>	Tube wells	3 : power up to 20 kW	Unity	Flat rate
<b>Bulk</b>	Railways, educational institutes, the military establishment, hospitals	3 : power at 415 V or 11 kV depending on their requirement, the load exceeding 10 kW		Flat rate
<b>Industrial (small)</b>	Atta chakkis, small workshop, sawmill, etc.	3 : power supply at 415 V, load not exceeding 20 kW	Usually high (0.8)	Block tariff
<b>Industrial (medium)</b>		3 : power supply at 415 V, the load exceeding 20 kW but not exceeding 100 kW		Two-part tariff
<b>Industrial (large)</b>		Power supplied at 11 kV or 33 kV, the load exceeding 100 kW	0.5	KVA maximum demand factor tariff

### Objectives of an Electricity Tariff

1. Recovery of cost of producing electrical energy at the power station.
2. Recovery of cost on the capital investment in transmission and distribution systems.
3. Recovery of cost of operation and maintenance of the supply of electrical energy. For example, metering equipment, billing, etc.
4. A suitable profit on the capital investment.
- 5.

### Electricity Tariff Characteristics

1. **Proper return.** The tariff should be structured in such a way that it guarantees the proper return from each consumer. The total receipts from the consumers must be equal to the cost of producing and supplying electrical energy plus the reasonable profit.
2. **Fairness.** The tariff must be fair so that each and every consumer is satisfied with the cost of electrical energy. Thus, a consumer who consumes more electrical energy should be charged at a lower rate than a consumer who consumes little energy. It is because increased energy consumption spreads the fixed charge over a greater number of units. Hence reducing the overall production cost of electrical energy.
3. **Simplicity.** The tariff should be simple and consumer-friendly so that an ordinary consumer can easily understand.
4. **Reasonable profit.** The profit element in the tariff should be reasonable. An electric supply company is a public utility company and generally enjoys the benefits of a monopoly.
5. **Attractive.** The tariff should be attractive so that it can attract a large number of consumers to use electricity.

## Types of Tariff in Electricity

### 1 Flat-Demand Tariff

This is one of the primitive forms of tariffs used for charging the consumer for consuming electrical energy. In this case, the total demand and the energy consumption are fixed. If  $x$  is the number of loads connected in kW and  $a$  is the rate per lamp or per kW of connected load, then

$$\text{Energy Charges} = \text{Rs. } ax$$

### 2 Simple Tariff

If there is a fixed rate available for per unit of energy consumed, then it is called a simple tariff or uniform rate tariff.

The rate can be delivered as

$\text{Cost/kWh} = \text{Rs. } \frac{\text{Annual fixed cost} + \text{Annual operating cost}}{\text{Total number of units supplied to the consumer per annum}}$

*Disadvantages*

- We cannot differentiate various types of consumers (domestic, industrial, bulk) having different load factor, diversity, and power factor.
- The cost per kWh delivered is higher.
- It does not encourage the use of electricity.

### **3 Flat-Rate Tariff**

When different types of consumers are charged at different per-unit rates, it is called a flat-rate tariff. In this type of tariff, the consumers are grouped into various categories, and each type of consumers is charged at a different rate. For instance, the flat rate per kWh for lighting load may be 60 paise, whereas it may slightly less (say 55 paise) for power load.

#### *Advantages*

- More fair to different types of consumers.
- Quite simple in calculations.

#### *Disadvantages*

- It varies with the consumption of electrical energy, and separate meters are required for lighting load, power load, etc. This makes the application of such tariff costly and complex.
- A particular category of consumers is charged at the same rate irrespective of the magnitude of energy consumed. However, big consumers should be charged at a relatively lower rate, as in this case the fixed charges per unit are reduced.

### **4 Step-Rate Tariff**

A step-rate tariff is a group of flat-rate tariffs of decreasing unit charges for a higher range of consumption. For example,

- Rs. 4.0/unit if the consumption does not exceed 50 kWh.
- Rs. 3.5/unit if the consumption exceeds 50 kW but does not exceed 200 kW.
- Rs. 3.0/unit if the consumption exceeds 200 kW.

#### *Disadvantage*

- However, by increasing the energy consumption, the cost is reduced. Thus, there is a tendency with the consumer, just approaching the limit of the step, to anyhow cross the step and enter the next one in order to reduce the total energy cost.

This drawback is removed in block-rate tariff explained below.

### **5 Block-Rate Tariff**

When a specific block of energy is charged at a specified rate and the succeeding blocks of energy are charged at a progressively reduced rate, it is called a block-rate tariff.

For example, the first 40 units may be charged at 70 paise/unit, next 35 units at 55 paise/unit, and remaining additional units at 30 paise/unit.

This is used for the majority of residential and small commercial consumers.

### ***Advantages***

- Consumers get an incentive to consume more electrical energy.
- This increases the load factor of the system and hence the cost of generation is reduced.

### ***Disadvantage***

- Its principal defect is that it cannot measure the consumer's demand.

## **6 Two-Part Tariff**

When the rate of electrical energy is charged on the basis of maximum demand of the consumers and the units consumed, then it is called two-part tariff or *Hopkinson demand tariff* (Table 1).

In this case, the total cost that is to be charged by the consumer is split into two components:

- *The fixed charges* depend upon the maximum demand of the consumers.
- *The running charges* depend upon the number of units consumed by the consumers.

$$\therefore \text{Total charges} = \text{Rs. } (b \times \text{kW} + c \times \text{kWh})$$

Where  $b$  is the charge per kW of maximum demand and  $c$  is the charge per kWh of energy consumed.

- Applicable to industrial consumers who have appreciable maximum demand.

### ***Advantages***

- Easily understood by the consumers.
- It recovers the fixed charges that depend upon the maximum demand of the consumer but are independent of the units consumed.

### ***Disadvantages***

- The consumer has to pay the fixed charges irrespective of whether he or she has consumed or not consumed the electric energy.
- There is always error in determining the maximum demand of the consumer.

## **7 Maximum-Demand Tariff**

It is quite similar to two-part tariff; the only difference is that the maximum demand is actually measured by installing maximum demand meter in the premises of the consumer.

### ***Advantage***

This eliminates the disadvantage of the two-part tariff, where maximum demand is determined merely on the basis of the chargeable value.

This tariff is mostly applied to big consumers.

## **8 Three-Part Tariff**

In three-part tariff, the total charge to be made from the consumer is split into three parts, that is,

- Fixed charges
- Semi-fixed charges
- Running charges

$$\therefore \text{Total charges} = \text{Rs. } (a + b \times \text{kW} + c \times \text{kWh})$$

Where  $a$  is the fixed charge made during each billing period. It includes interest and depreciation on the cost of secondary distribution and labor cost of collecting revenues.  $b$  is the charge per kW of maximum demand and  $c$  is the charge per kWh of energy consumed.

The principal objection of this tariff is that the charges are split into three compartments. Generally applied to big consumers.

## **9 Power Factor Tariff**

The tariff in which the power factor of the consumer's load is taken into consideration is known as *power factor tariff*.

A low-power-factor increases the rating of the station equipment and line losses. Therefore, a consumer having low-power-factor must be penalized.

**The following are the important types of power factor tariff.**

### ***9.1 kVA Maximum-Demand Tariff***

It is a modified form of the two-part tariff. The fixed charges are formulated on the basis of maximum demand in kVA, and not in kW. As kVA is inversely proportional to the power factor, a consumer having a low-power-factor has to contribute more toward the fixed charges.

*Advantage*

It encourages the consumers to operate the appliances and machinery at improved power factor.

### ***9.2 Sliding Scale Tariff***

This is known as average power factor tariff. In this case, an average power factor (say 0.8 lagging) is taken as the reference. If the power factor of the consumer falls below this factor, suitable additional charges are made. On the other hand, if the power factor is above the reference, a discount is allowed to the consumers.

### ***9.3 kW and kvar Tariff***

In this type, both active power (kW) and reactive power (kvar) supplied are charged separately. A consumer having low-power-factor will draw more reactive power and hence shall have to pay more charges.

## Electricity Tariff Example 1

The maximum demand of a consumer is 15 A at 230 V and his/her total energy consumption is 9000 kWh. If the energy is charged at the rate of Rs. 5 per unit for 600 h use of the maximum demand per annum plus Rs. 2 per unit for additional units, calculate (1) annual bill and (2) equivalent flat rate.

### Solution

Assume the load factor and power factor to be unity.

$$\text{Maximum Demand} = 230 \times 15 \times 1 / 1000 = 3.45 \text{ kW}$$

$$1. \text{ Units consumed in 600 h} = 3.45 \times 600 = 2070 \text{ kWh}$$

$$\text{charges for 2070 kWh} = \text{Rs. } 5 \times 2070 = \text{Rs. } 10,350$$

$$\text{Remaining Units} = 9000 - 2070 = 6930 \text{ kWh}$$

$$\text{charges for 6930 kWh} = \text{Rs. } 2 \times 6930 = \text{Rs. } 13,860$$

$$\text{Total Annual Bill} = \text{Rs. } (13,860 + 10,350) = \text{Rs. } 24,210.$$

$$\text{Equivalent Flat Rate} = \text{Rs. } 24,210 / 9000 = \text{Rs. } 2.69$$

## Electricity Tariff Example 2

A consumer has a maximum demand of 150 kW at 50% load factor. If the tariff is Rs. 800 per kW of maximum demand plus Rs. 2 per kWh, find the overall cost per kWh.

### Solution

$$\text{Units Consumed/Year} = \text{MD} \times \text{LF} \times \text{Hours in a year}$$

$$= 150 \times 0.5 \times 8760 = 657,000 \text{ kWh}$$

$$\text{Annual Charges} = \text{Annual MD Charges} + \text{Annual Energy Charges} = \text{Rs. } (150 \times 800 + 2 \times 657,000)$$

$$= 1,434,000$$

$$\therefore \text{Overall Cost / kWh} = \text{Rs. } 1,434,000 / 657,000 = \text{Rs. } 2.18$$

## 1.16 Calculation of electric bill for a company

Electrical utility or power supplying companies charge industrial customers not only based on the amount of energy used (kWh) but also on the peak demand (kVA) for each month.

### Contract Demand

Contract demand is the amount of electric power that a customer demands from utility in a specified interval. Unit used is kVA or kW. It is the amount of electric power that the consumer agreed upon with the utility. This would mean that utility has to plan for the specified capacity.

## Maximum demand

Maximum demand is the highest average kVA recorded during any one-demand interval within the month. The demand interval is normally 30 minutes, but may vary from utility to utility from 15 minutes to 60 minutes. The demand is measured using a tri-vector meter / digital energy meter.

## Prediction of Load

While considering the methods of load prediction, some of the terms used in connection with power supply must be appreciated.

**Connected Load** - is the nameplate rating (in kW or kVA) of the apparatus installed on a consumer's premises.

**Demand Factor** - is the ratio of maximum demand to the connected load.

**Load Factor** - The ratio of average load to maximum load.

$$\text{Load Factor} = \frac{\text{Average Load}}{\text{Maximum Load}}$$

The load factor can also be defined as the ratio of the energy consumed during a given period to the energy, which would have been used if the maximum load had been maintained throughout that period. For example, load factor for a day (24 hours) will be given by:

$$\text{Load Factor} = \frac{\text{Energy consumed during 24 hours}}{\text{Maximum load recorded} \times 24 \text{ Hours}}$$

## PF Measurement

A power analyzer can measure PF directly, or alternately kWh, kVAh or kVArh readings are recorded from the billing meter installed at the incoming point of supply. The relation kWh / kVAh gives the power factor.

## Time of Day (TOD) Tariff

Many electrical utilities like to have flat demand curve to achieve high plant efficiency. They encourage user to draw more power during off-peak hours (say during night time) and less power during peak hours. As per their plan, they offer TOD Tariff, which may be incentives or disincentives. Energy meter will record peak and nonpeak consumption separately by timer control. TOD tariff gives opportunity for the user to reduce their billing, as off peak hour tariff charged are quite low in comparison to peak hour tariff.

## 1.17 EB billing- HT and LT supply

The electricity billing by utilities for medium & large enterprises, in High Tension (HT) category, is often done on two-part tariff structure, i.e. one part for capacity (or demand) drawn and the second part for actual energy drawn during the billing cycle. Capacity or demand is in kVA (apparent power) or kW terms. The reactive energy (i.e.) kVArh drawn by the service is also recorded and billed for in some utilities, because this would affect the load on the utility. Accordingly, utility charges for maximum demand, active energy and reactive power drawn



(as reflected by the power factor) in its billing structure. In addition, other fixed and variable expenses are also levied.

The tariff structure generally includes the following components:

**a) Maximum demand Charges**

These charges relate to maximum demand registered during month/billing period and corresponding rate of utility.

**b) Energy Charges**

These charges relate to energy (kilowatt hours) consumed during month / billing period and corresponding rates, often levied in slabs of use rates. Some utilities now charge on the basis of apparent energy (kVAh), which is a vector sum of kWh and kVArh.

**c) Power factor penalty or bonus rates**, as levied by most utilities, are to contain reactive power drawn from grid.

**d) Fuel cost adjustment charges** as levied by some utilities are to adjust the increasing fuel expenses over a base reference value.

**e) Electricity duty charges** levied w.r.t units consumed.

**f) Meter rentals**

g) Lighting and fan power consumption is often at higher rates, levied sometimes on slab basis or on actual metering basis.

**h) Time of Day (TOD) rates** like peak and non-peak hours are also prevalent in tariff structure provisions of some utilities.

**i) Penalty for exceeding contract demand**

**j) Surcharge** if metering is at LT side in some of the utilities

Analysis of utility bill data and monitoring its trends helps energy manager to identify ways for electricity bill reduction through available provisions in tariff framework, apart from energy budgeting

The utility employs an electromagnetic or electronic trivector meter, for billing purposes. The minimum outputs from the electromagnetic meters are

- Maximum demand registered during the month, which is measured in preset time intervals (say of 30 minute duration) and this is reset at the end of every billing cycle.
- Active energy in kWh during billing cycle
- Reactive energy in kVArh during billing cycle and
- Apparent energy in kVAh during billing cycle

It is important to note that while maximum demand is recorded, it is not the instantaneous demand drawn, as is often misunderstood, but the time integrated demand over the predefined recording cycle.

As example, in an industry, if the draw over a recording cycle of 30 minutes is :

2500 kVA for 4 minutes  
3600 kVA for 12 minutes  
4100 kVA for 6 minutes  
3800 kVA for 8 minutes

The MD recorder will be computing MD as:

$$\frac{(2500 \times 4) + (3600 \times 12) + (4100 \times 6) + (3800 \times 8)}{30} = 3606.7 \text{ kVA}$$

The month's maximum demand will be the highest among such demand values recorded over the month. The meter registers only if the value exceeds the previous maximum demand value and thus, even if, average maximum demand is low, the industry / facility has to pay for the maximum demand charges for the highest value registered during the month, even if it occurs for just one recording cycle duration i.e., 30 minutes during whole of the month. A typical demand curve is shown in Figure 1.4.

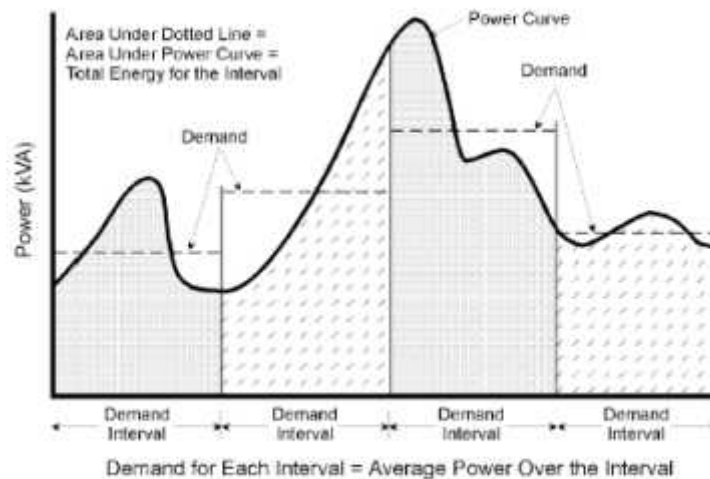

Figure 1.4 Demand Curve

As can be seen from the Figure 1.4 above the demand varies from time to time. The demand is measured over predetermined time interval and averaged out for that interval as shown by the horizontal dotted line.

Of late most electricity boards have changed over from conventional electromechanical trivector meters to electronic meters, which have some excellent provisions that can help the utility as well as the industry. These provisions include:

- Substantial memory for logging and recording all relevant events
- High accuracy up to 0.2 class
- Amenability to time of day tariffs
- Tamper detection /recording
- Measurement of harmonics and Total Harmonic Distortion (THD)

- Long service life due to absence of moving parts
- Amenability for remote data access/downloads

Trend analysis of purchased electricity and cost components can help the industry to identify key result areas for bill reduction within the utility tariff available framework along the following lines.

TABLE 1.1 PURCHASED ELECTRICAL ENERGY TREND										
Month & Year	MD Recorded kVA	Billing Demand* kVA	Total Energy Consumption kWh	Energy Consumption During Peak Hours (kWh)	MD Charge Rs./kVA	Energy Charge Rs./kWh	PF	PF Penalty/Rebate Rs.	Total Bills Rs.	Average Cost Rs./kWh
Jan.										
Feb.										
.....										
.....										
.....										
Dec.										

\*Some utilities charge Maximum Demand on the basis of minimum billing demand, which may be between 75 to 100% of the contract demand or actual recorded demand whichever is higher

## 1.18 Transformers:

A transformer can accept energy at one voltage and deliver it at another voltage. This permits electrical energy to be generated at relatively low voltages and transmitted at high voltages and low currents, thus reducing line losses and voltage drop (see Figure 1.10). Transformers consist of two or more coils that are electrically insulated, but magnetically linked. The primary coil is connected to the power source and the secondary coil connects to the load. The turn's ratio is the ratio between the number of turns on the secondary to the turns on the primary (See Figure 1.11). The secondary voltage is equal to the primary voltage times the turn's ratio. Ampere-turns are calculated by multiplying the current in the coil times the number of turns. Primary ampere-turns are equal to secondary ampere-turns. Voltage regulation of a transformer is the percent increase in voltage from full load to no load.

### Types of Transformers

Transformers are classified as two categories: power transformers and distribution transformers.

Power transformers are used in transmission network of higher voltages, deployed for step-up and step down transformer application (400 kV, 200 kV, 110 kV, 66 kV, 33kV)

Distribution transformers are used for lower voltage distribution networks as a means to end user connectivity. (11kV, 6.6 kV, 3.3 kV, 440V, 230V)

### Rating of Transformer

Rating of the transformer is calculated based on the connected load and applying the diversity factor on the connected load, applicable to the particular industry and arrive at the kVA rating

of the Transformer. Diversity factor is defined as the ratio of overall maximum demand of the plant to the sum of individual maximum demand of various equipment. Diversity factor varies from industry to industry and depends on various factors such as individual loads, load factor and future expansion needs of the plant. Diversity factor will always be less than one.

### Location of Transformer

Location of the transformer is very important as far as distribution loss is concerned. Transformer receives HT voltage from the grid and steps it down to the required voltage. Transformers should be placed close to the load centre, considering other features like optimisation needs for centralised control, operational flexibility etc. This will bring down the distribution loss in cables.

### Transformer Losses and Efficiency

The efficiency varies anywhere between 96 to 99 percent. The efficiency of the transformers not only depends on the design, but also, on the effective operating load.

Transformer losses consist of two parts: No-load loss and Load loss

1. No-load loss (also called core loss) is the power consumed to sustain the magnetic field in the transformer's steel core. Core loss occurs whenever the transformer is energized; core loss does not vary with load. Core losses are caused by two factors: hysteresis and eddy current losses. Hysteresis loss is that energy lost by reversing the magnetic field in the core as the magnetizing AC rises and falls and reverses direction. Eddy current loss is a result of induced currents circulating in the core.

2. Load loss (also called copper loss) is associated with full-load current flow in the transformer windings. Copper loss is power lost in the primary and secondary windings of a transformer due to the ohmic resistance of the windings. Copper loss varies with the square of the load current. ( $P = I^2 R$ ).

Transformer losses as a percentage of load is given in the Figure 1.12.

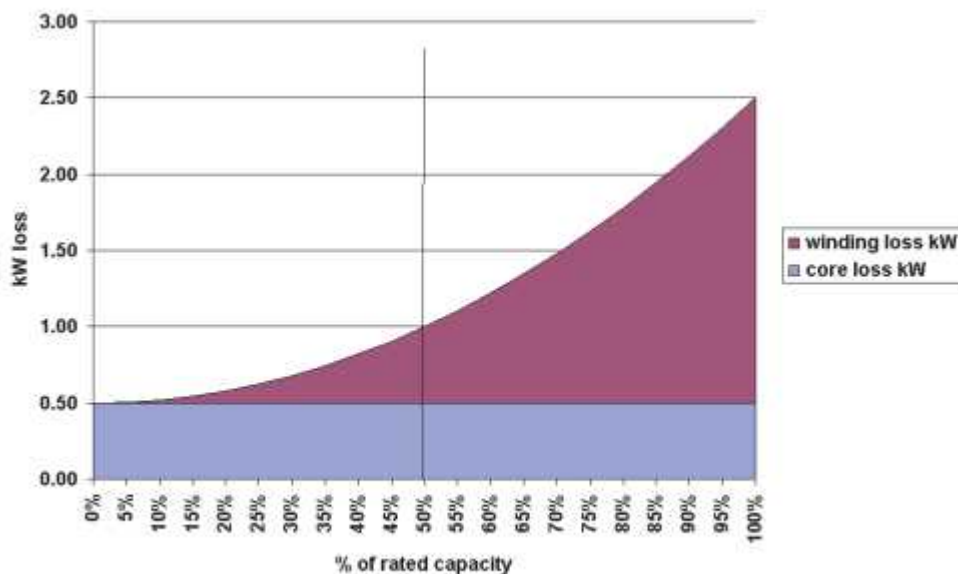

Figure 1.12 Transformer loss vs %Load

For a given transformer, the manufacturer can supply values for no-load loss,  $P_{NO-LOAD}$ , and load loss,  $P_{LOAD}$ . The total transformer loss,  $P_{TOTAL}$ , at any load level can then be calculated from:

$$P_{TOTAL} = P_{NO-LOAD} + (\% \text{ Load}/100)^2 \times P_{LOAD}$$

Where transformer loading is known, the actual transformers loss at given load can be computed as:

$$= \text{No load loss} + \left( \frac{\text{kVA Load}}{\text{Rated kVA}} \right)^2 \times (\text{full load loss})$$

### **Voltage Fluctuation Control**

A control of voltage in a transformer is important due to frequent changes in supply voltage level. Whenever the supply voltage is less than the optimal value, there is a chance of nuisance tripping of voltage sensitive devices. The voltage regulation in transformers is done by altering the voltage transformation ratio with the help of tapping. There are two methods of tap changing facility available: **Off-circuit tap changer and On-load tap changer**.

#### **Off-circuit tap changer**

It is a device fitted in the transformer, which is used to vary the voltage transformation ratio. Here the voltage levels can be varied only after isolating the primary voltage of the transformer.

#### **On load tap changer (OLTC)**

The voltage levels can be varied without isolating the connected load to the transformer. To minimise the magnetisation losses and to reduce the nuisance tripping of the plant, the main transformer (the transformer that receives supply from the grid) should be provided with On Load Tap Changing facility at design stage. The down stream distribution transformers can be provided with off-circuit tap changer. The On-load gear can be put in auto mode or manually depending on the requirement. OLTC can be arranged for transformers of size 250 kVA onwards. However, the necessity of OLTC below 1000 kVA can be considered after calculating the cost economics.

### **Parallel Operation of Transformers**

The design of Power Control Centre (PCC) and Motor Control Centre (MCC) of any new plant should have the provision of operating two or more transformers in parallel. Additional switchgears and bus couplers should be provided at design stage. Whenever two transformers are operating in parallel, both should be technically identical in all aspects and more importantly should have the same impedance level. This will minimise the circulating current between transformers. Where the load is fluctuating in nature, it is preferable to have more than one transformer running in parallel, so that the load can be optimised by sharing the load between transformers. The transformers can be operated close to the maximum efficiency range by this operation.

## 1.19 Electric motors- motor efficiency computation, energy efficient motors

### 1.19.0 Introduction

Motors convert electrical energy into mechanical energy by the interaction between the magnetic fields set up in the stator and rotor windings. Industrial electric motors can be broadly classified as induction motors, direct current motors or synchronous motors. All motor types have the same four operating components: stator (stationary windings), rotor (rotating windings), bearings, and frame (enclosure).

### 1.19.1 Motor Types

#### Direct-Current Motors

Direct-Current motors, as the name implies, use direct-unidirectional, current. Direct current motors are used in special applications- where high torque starting or where smooth acceleration over a broad speed range is required.

#### Induction Motors

Induction motors are the most commonly used prime mover for various equipments in industrial applications. In induction motors, the induced magnetic field of the stator winding induces a current in the rotor. This induced rotor current produces a second magnetic field, which tries to oppose the stator magnetic field, and this causes the rotor to rotate.

The 3-phase squirrel cage motor is the workhorse of industry; it is rugged and reliable, and is by far the most common motor type used in industry. These motors drive pumps, blowers and fans, compressors, conveyers and production lines. The 3-phase induction motor has three windings each connected to a separate phase of the power supply.

#### Synchronous Motors

AC power is fed to the stator of the synchronous motor. The rotor is fed by DC from a separate source. The rotor magnetic field locks onto the stator rotating magnetic field and rotates at the same speed. The speed of the rotor is a function of the supply frequency and the number of magnetic poles in the stator. While induction motors rotate with a slip, i.e., rpm is less than the synchronous speed, the synchronous motor rotate with no slip, i.e., the RPM is same as the synchronous speed governed by supply frequency and number of poles. The slip energy is provided by the D.C. excitation power

### 1.19.2 Motor Characteristics

#### Motor Speed

The speed of a motor is the number of revolutions in a given time frame, typically revolutions per minute (RPM). The speed of an AC motor depends on the frequency of the input power and the number of poles for which the motor is wound. The synchronous speed in RPM is given by the following equation, where the frequency is in hertz or cycles per second:

$$\text{Synchronous Speed (RPM)} = \frac{120 \times \text{Frequency}}{\text{No. of Poles}}$$

Indian motors have synchronous speeds like 3000 / 1500 / 1000 / 750 / 600 / 500 / 375 RPM corresponding to no. of poles being 2, 4, 6, 8, 10, 12, 16 (always even) and given the mains frequency of 50 cycles / sec.

### Slip

The actual speed, with which the motor operates, will be less than the synchronous speed. The difference between synchronous and full load speed is called slip and is measured in percent. It is calculated using this equation:

$$\text{Slip (\%)} = \frac{\text{Synchronous Speed} - \text{Full Load Rated Speed}}{\text{Synchronous Speed}} \times 100$$

As per relation stated above, the speed of an AC motor is determined by the number of motor poles and by the input frequency. It can also be seen that theoretically speed of an AC motor can be varied infinitely by changing the frequency. Manufacturer's guidelines should be referred for practical limits to speed variation. With the addition of a Variable Frequency Drive (VFD), the speed of the motor can be decreased as well as increased.

### Power Factor

The power factor of the motor is given as:

$$\text{Power Factor} = \cos \phi = \frac{\text{kW}}{\text{kVA}}$$

As the load on the motor comes down, the magnitude of the active current reduces. However, there is no corresponding reduction in the magnetizing current, which is proportional to supply voltage with the result that the motor power factor reduces, with a reduction in applied load. Induction motors, especially those operating below their rated capacity, are the main reason for low power factor in electric systems.

### Motor Efficiency

Two important attributes relating to efficiency of electricity use by A.C. Induction motors are efficiency (  $\eta$  ), defined as the ratio of the mechanical energy delivered at the rotating shaft to the electrical energy input at its terminals, and power factor (PF). Motors, like other inductive loads, are characterized by power factors less than one. As a result, the total current draw needed to deliver the same real power is higher than for a load characterized by a higher PF. An important effect of operating with a PF less than one is that resistance losses in wiring upstream of the motor will be higher, since these are proportional to the square of the current. Thus, both a high value for  $\eta$  and a PF close to unity are desired for efficient overall operation in a plant.

Squirrel cage motors are normally more efficient than slip-ring motors, and higher-speed motors are normally more efficient than lower-speed motors. Efficiency is also a function of motor temperature. Totally-enclosed, fan-cooled (TEFC) motors are more efficient than screen protected, drip-proof (SPDP) motors. Also, as with most equipment, motor efficiency increases with the rated capacity.



The efficiency of a motor is determined by intrinsic losses that can be reduced only by changes in motor design. Intrinsic losses are of two types: fixed losses - independent of motor load, and variable losses - dependent on load.

**Fixed losses** consist of magnetic core losses and friction and windage losses. Magnetic core losses (sometimes called iron losses) consist of eddy current and hysteresis losses in the stator. They vary with the core material and geometry and with input voltage. Friction and windage losses are caused by friction in the bearings of the motor and aerodynamic losses associated with the ventilation fan and other rotating parts.

**Variable losses** consist of resistance losses in the stator and in the rotor and miscellaneous stray losses. Resistance to current flow in the stator and rotor result in heat generation that is proportional to the resistance of the material and the square of the current ( $I^2 R$ ). Stray losses arise from a variety of sources and are difficult to either measure directly or to calculate, but are generally proportional to the square of the rotor current.

Part-load performance characteristics of a motor also depend on its design. Both  $\eta$  and PF fall to very low levels at low loads. The Figures 2.1 shows the effect of load on power factor and efficiency. It can be seen that power factor drops sharply at part loads. The Figure 2.2 shows the effect of speed on power factor.

### 1.19.3 Field Tests for Determining Efficiency

**No Load Test:** The motor is run at rated voltage and frequency without any shaft load. Input power, current, frequency and voltage are noted. The no load P.F. is quite low and hence low PF wattmeters are required. From the input power, stator  $I^2 R$  losses under no load are subtracted to give the sum of Friction and Windage (F&W) and core losses. To separate core and F & W losses, test is repeated at variable voltages. It is useful to plot no-load input kW versus Voltage; the intercept is Friction & Windage kW loss component.

$$\text{F\&W and core losses} = \text{No load power (watts)} - (\text{No load current})^2 \times \text{Stator resistance}$$

**Stator and Rotor  $I^2 R$  Losses:** The stator winding resistance is directly measured by a bridge or volt amp method. The resistance must be corrected to the operating temperature. For modern motors, the operating temperature is likely to be in the range of 100°C to 120°C and necessary correction should be made. Correction to 75°C may be inaccurate. The correction factor is given as follows :

$$\frac{R_2}{R_1} = \frac{235 + t_2}{235 + t_1}, \text{ where, } t_1 = \text{ambient temperature, } ^\circ\text{C} \text{ \& } t_2 = \text{operating temperature, } ^\circ\text{C}.$$

The rotor resistance can be determined from locked rotor test at reduced frequency, but rotor  $I^2 R$  losses are measured from measurement of rotor slip.

$$\text{Rotor } I^2 R \text{ losses} = \text{Slip} \times (\text{Stator Input} - \text{Stator } I^2 R \text{ Losses} - \text{Core Loss})$$

Accurate measurement of slip is possible by stroboscope or non-contact type tachometer. Slip also must be corrected to operating temperature.

**Stray Load Losses:** These losses are difficult to measure with any accuracy. **IEEE Standard 112** gives a complicated method, which is rarely used on shop floor. IS and IEC standards take

a fixed value as 0.5 % of input. The actual value of stray losses is likely to be more. IEEE – 112 specifies values from 0.9 % to 1.8 % (see Table 2.1.)

<b>TABLE 2.1 MOTOR RATING VS. STRAY LOSSES - IEEE</b>	
<b>Motor Rating</b>	<b>Stray Losses</b>
1 – 125 HP	1.8 %
125 – 500 HP	1.5 %
501 – 2499 HP	1.2 %
2500 and above	0.9 %

#### **1.19.4 Pointers for Users:**

It must be clear that accurate determination of efficiency is very difficult. The same motor tested by different methods and by same methods by different manufacturers can give a difference of 2 %. In view of this, for selecting high efficiency motors, the following can be done:

- a) When purchasing large number of small motors or a large motor, ask for a detailed test certificate. If possible, try to remain present during the tests; this will add cost.
- b) See that efficiency values are specified without any tolerance
- c) Check the actual input current and kW, if replacement is done
- d) For new motors, keep a record of no load input power and current
- e) Use values of efficiency for comparison and for confirming; rely on measured inputs for all calculations.  $R_2 \frac{235 + t_2}{235 + t_1} = \dots$ , where,  $t_1$  = ambient temperature, °C &  $t_2$  = operating temperature, °C.  $R_1 \frac{235 + t_1}{235 + t_2} = \dots$

Estimation of efficiency in the field can be done as follows:

- a) Measure stator resistance and correct to operating temperature. From rated current value,  $I^2 R$  losses are calculated.
- b) From rated speed and output, rotor  $I^2 R$  losses are calculated
- c) From no load test, core and F & W losses are determined for stray loss

### 1.19.5 The method is illustrated by the following example:

#### Example:

##### Motor Specifications

Rated power	=	34 kW/45 HP
Voltage	=	415 Volt
Current	=	57 Amps
Speed	=	1475 rpm
Insulation class	=	F
Frame	=	LD 200 L
Connection	=	Delta

##### No load test Data

Voltage, V	=	415 Volts
Current, I	=	16.1 Amps
Frequency, F	=	50 Hz
Stator phase resistance at 30°C	=	0.264 Ohms
No load power, P <sub>nl</sub>	=	1063.74 Watts

- Calculate iron plus friction and windage losses
- Calculate stator resistance at 120°C

$$R_2 = R_1 \times \frac{235 + t_2}{235 + t_1}$$

- Calculate stator copper losses at operating temperature of resistance at 120°C
- Calculate full load slip(s) and rotor input assuming rotor losses are slip times rotor input.
- Determine the motor input assuming that stray losses are 0.5 % of the motor rated power
- Calculate motor full load efficiency and full load power factor

##### Solution

- Let Iron plus friction and windage loss, P<sub>i</sub> + f<sub>w</sub>  
No load power, P<sub>nl</sub> = 1063.74 Watts

Stator Copper loss, P<sub>st-30°C</sub> (P<sub>st.cu</sub>)

$$= 3 \times (16.1 / \sqrt{3})^2 \times 0.264$$

$$= 68.43 \text{ Watts}$$

$$P_i + f_w = P_{nl} - P_{st.cu}$$

$$= 1063.74 - 68.43$$

$$= 995.3 \text{ W}$$

b) Stator Resistance at 120°C,

$$R_{120^{\circ}\text{C}} = 0.264 \times \frac{120 + 235}{30 + 235}$$
$$= 0.354 \text{ ohms per phase}$$

c) Stator copper losses at full load, Pst.cu 120°C

$$= 3 \times (57 / \sqrt{3})^2 \times 0.354$$
$$= 1150.1 \text{ Watts}$$

d) Full load slip

$$S = (1500 - 1475) / 1500$$
$$= 0.0167$$

$$\begin{aligned} \text{Rotor input, Pr} &= P_{\text{output}} / (1-S) \\ &= 34000 / (1-0.0167) \\ &= 34577.4 \text{ Watts} \end{aligned}$$

e) Motor full load input power, P input

$$\begin{aligned} &= P_r + P_{\text{st.cu } 120^{\circ}\text{C}} + (P_i + fw) + P_{\text{stray}} \\ &= 34577.4 + 1150.1 + 995.3 + (0.005^* \times 34000) \\ &= 36892.8 \text{ Watts} \end{aligned}$$

\*where, stray losses = 0.5% of rated output (assumed)

f) Motor efficiency at full load

$$\begin{aligned} \text{Efficiency} &= \frac{P_{\text{output}}}{P_{\text{input}}} \times 100 \\ &= \frac{34000}{36892.8} \times 100 \\ &= 92.2 \% \end{aligned}$$

$$\begin{aligned}
 \text{Full Load PF} &= \frac{P_{\text{input}}}{\sqrt{3} \times V \times I_{\text{fl}}} \\
 &= \frac{36892.8}{\sqrt{3} \times 415 \times 57} \\
 &= 0.90
 \end{aligned}$$

**Comments :**

- a) The measurement of stray load losses is very difficult and not practical even on test beds.
- b) The actual value of stray loss of motors up to 200 HP is likely to be 1 % to 3 % compared to 0.5 % assumed by standards.
- c) The value of full load slip taken from the nameplate data is not accurate. Actual measurement under full load conditions will give better results.
- d) The friction and windage losses really are part of the shaft output; however, in the above calculation, it is not added to the rated shaft output before calculating the rotor input power. The error however is minor.
- e) When a motor is rewound, there is a fair chance that the resistance per phase would increase due to winding material quality and the losses would be higher. It would be interesting to assess the effect of a nominal 10 % increase in resistance per phase.

### 1.19.6 Energy-Efficient Motors

Energy-efficient motors (EEM) are the ones in which, design improvements are incorporated specifically to increase operating efficiency over motors of standard design (see Figure 2.3). Design improvements focus on reducing intrinsic motor losses. Improvements include the use of lower-loss silicon steel, a longer core (to increase active material), thicker wires (to reduce resistance), thinner laminations, smaller air gap between stator and rotor, copper instead of aluminium bars in the rotor, superior bearings and a smaller fan, etc.

Energy-efficient motors now available in India operate with efficiencies that are typically 3 to 4 percentage points higher than standard motors. In keeping with the stipulations of the BIS, energy-efficient motors are designed to operate without loss in efficiency at loads between 75 % and 100 % of rated capacity. This may result in major benefits in varying load applications. The power factor is about the same or may be higher than for standard motors. Furthermore, energy

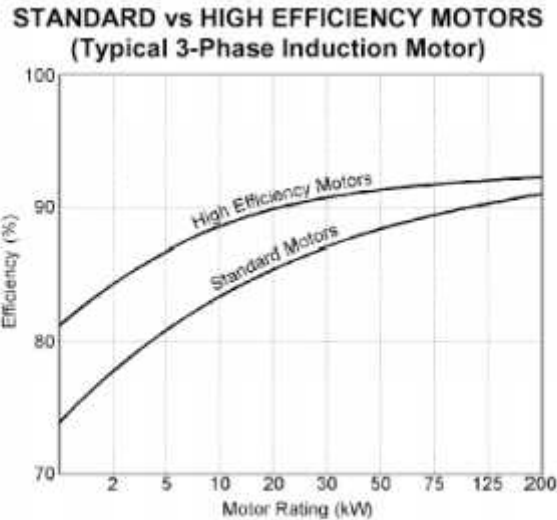

**Figure 2.3 Standard vs High Efficiency Motors**

efficient motors have lower operating temperatures and noise levels, greater ability to accelerate higher-inertia loads, and are less affected by supply voltage fluctuations.

Measures adopted for energy efficiency address each loss specifically as under:

**Stator and Rotor I<sup>2</sup> R Losses**

These losses are major losses and typically account for 55% to 60% of the total losses. I<sup>2</sup> R losses are heating losses resulting from current passing through stator and rotor conductors. I<sup>2</sup> R losses are the function of a conductor resistance, the square of current. Resistance of conductor is a function of conductor material, length and cross sectional area. The suitable selection of copper conductor size will reduce the resistance. Reducing the motor current is most readily accomplished by decreasing the magnetizing component of current. This involves lowering the operating flux density and possible shortening of air gap. Rotor I<sup>2</sup> R losses are a function of the rotor conductors (usually aluminium) and the rotor slip. Utilisation of copper conductors will reduce the winding resistance. Motor operation closer to synchronous speed will also reduce rotor I<sup>2</sup> R losses.

**Core Losses**

Core losses are those found in the stator-rotor magnetic steel and are due to hysteresis effect and eddy current effect during 50 Hz magnetization of the core material. These losses are independent of load and account for 20 – 25 % of the total losses. The hysteresis losses which are a function of flux density, are reduced by utilizing lowloss grade of silicon steel laminations. The reduction of flux density is achieved by suitable increase in the core length of stator and rotor. Eddy current losses are generated by circulating current within the core steel laminations. These are reduced by using thinner laminations.

**Friction and Windage Losses**

Friction and windage losses results from bearing friction, windage and circulating air through the motor and account for 8 – 12 % of total losses. These losses are independent of load. The reduction in heat generated by stator and rotor losses permit the use of smaller fan. The windage losses also reduce with the diameter of fan leading to reduction in windage losses.

## Stray Load-Losses

These losses vary according to square of the load current and are caused by leakage flux induced by load currents in the laminations and account for 4 to 5 % of total losses. These losses are reduced by careful selection of slot numbers, tooth/slot geometry and air gap.

**Energy efficient motors cover a wide range of ratings and the full load efficiencies are higher by 3 to 7 %. The mounting dimensions are also maintained as per IS1231 to enable easy replacement**

As a result of the modifications to improve performance, the costs of energy-efficient motors are higher than those of standard motors. The higher cost will often be paid back rapidly in saved operating costs, particularly in new applications or end-of-life motor replacements. In cases where existing motors have not reached the end of their useful life, the economics will be less clearly positive.

Because the favourable economics of energy-efficient motors are based on savings in operating costs, there may be certain cases which are generally economically ill-suited to energyefficient motors. These include highly intermittent duty or special torque applications such as hoists and cranes, traction drives, punch presses, machine tools, and centrifuges. In addition, energy, efficient designs of multi-speed motors are generally not available. Furthermore, energy-efficient motors are not yet available for many special applications, e.g. for flame-proof operation in oil-field or fire pumps or for very low speed applications (below 750 rpm). Also, most energy-efficient motors produced today are designed only for continuous duty cycle operation.

Given the tendency of over sizing on the one hand and ground realities like ; voltage, frequency variations, efficacy of rewinding in case of a burnout, on the other hand, benefits of EEM's can be achieved only by careful selection, implementation, operation and maintenance efforts of energy managers.

A summary of energy efficiency improvements in EEMs is given in the Table 2.2:

TABLE 2.2 ENERGY EFFICIENT MOTORS	
Power Loss Area	Efficiency Improvement
1. Iron	Use of thinner gauge, lower loss core steel reduces eddy current losses. Longer core adds more steel to the design, which reduces losses due to lower operating flux densities.
2. Stator $I^2R$	Use of more copper and larger conductors increases cross sectional area of stator windings. This lowers resistance ( $R$ ) of the windings and reduces losses due to current flow ( $I$ ).
3. Rotor $I^2R$	Use of larger rotor conductor bars increases size of cross section, lowering conductor resistance ( $R$ ) and losses due to current flow ( $I$ ).
4. Friction & Windage	Use of low loss fan design reduces losses due to air movement.
5. Stray Load Loss	Use of optimized design and strict quality control procedures minimizes stray load losses.



## 1.20 Pumps:

### 1.20.0 Pumps

- A pump is a machine for raising a liquid - a relatively **incompressible** fluid - to a higher level of pressure or head

### 1.20.1 Pump Types

Pumps come in a variety of sizes for a wide range of applications. They can be classified according to their basic operating principle as dynamic or displacement pumps. Dynamic pumps can be sub-classified as centrifugal and special effect pumps. Displacement pumps can be sub-classified as rotary or reciprocating pumps.

In principle, any liquid can be handled by any of the pump designs. Where different pump designs could be used, the centrifugal pump is generally the most economical followed by rotary and reciprocating pumps. Although, positive displacement pumps are generally more efficient than centrifugal pumps, the benefit of higher efficiency tends to be offset by increased maintenance costs.

Since, worldwide, centrifugal pumps account for the majority of electricity used by pumps, the focus of this chapter is on centrifugal pump.

Pumps are in general classified as Centrifugal Pumps (or Roto-dynamic pumps) and Positive Displacement Pumps.

### Centrifugal Pumps (Roto-dynamic pumps)

The centrifugal or roto-dynamic pump produce a head and a flow by increasing the velocity of the liquid through the machine with the help of the rotating vane impeller. Centrifugal pumps include radial, axial and mixed flow units.

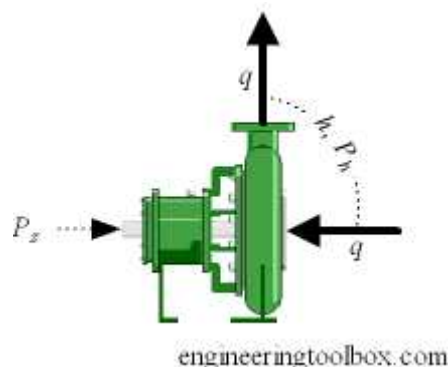

Centrifugal pumps can be classified further as

- end suction pumps
- in-line pumps

- double suction pumps
- vertical multistage pumps
- horizontal multistage pumps
- submersible pumps
- self-priming pumps
- axial-flow pumps
- regenerative pumps

### **Positive Displacement Pumps**

A positive displacement pump operates by alternating filling a cavity and then displacing a given volume of liquid. A positive displacement pump delivers a constant volume of liquid for each cycle independent of discharge pressure or head.

The positive displacement pump can be classified as:

- Reciprocating pumps - piston, plunger and diaphragm
- Power pumps
- Steam pumps
- Rotary pumps - gear, lobe, screw, vane, regenerative (peripheral) and progressive cavity

### **Selecting between Centrifugal or Positive Displacement Pumps**

Selecting between a Centrifugal Pump or a Positive Displacement Pump is not always straight forward.

#### ***Flow Rate and Pressure Head***

The two types of pumps behave very differently regarding pressure head and flow rate:

- The Centrifugal Pump has varying flow depending on the system pressure or head
- The Positive Displacement Pump has more or less a constant flow regardless of the system pressure or head. Positive Displacement pumps generally makes more pressure than Centrifugal Pump's.

#### ***Capacity and Viscosity***

Another major difference between the pump types is the effect of viscosity on capacity:

- In a Centrifugal Pump the flow is reduced when the viscosity is increased
- In a Positive Displacement Pump the flow is increased when viscosity is increased

Liquids with high viscosity fills the clearances of Positive Displacement Pumps causing higher volumetric efficiencies and Positive Displacement Pumps are better suited for higher viscosity applications. A Centrifugal Pump becomes very inefficient at even modest viscosity.

#### ***Mechanical Efficiency***

The pumps behaves different considering mechanical efficiency as well.

- Changing the system pressure or head has little or no effect on the flow rate in a Positive Displacement Pump
- Changing the system pressure or head may have a dramatic effect on the flow rate in a Centrifugal Pump

### **Net Positive Suction Head - NPSH**

Another consideration is the Net Positive Suction Head - NPSH.

- In a Centrifugal Pump, NPSH varies as a function of flow determined by pressure
- In a Positive Displacement Pump, NPSH varies as a function of flow determined by speed. Reducing the speed of the Positive Displacement Pump pump, reduces the NPSH

### **Hydraulic power, pump shaft power and electrical input power**

**Hydraulic power  $P_h = Q$  (m<sup>3</sup>/s) x Total head,  $h_d - h_s$  (m) x  $\rho$  (kg/m<sup>3</sup>) x  $g$  (m/s<sup>2</sup>) / 1000**

*Where  $h_d$  – discharge head,  $h_s$  – suction head,  $\rho$  – density of the fluid,  $g$  – acceleration due to gravity*

**Pump shaft power  $P_s =$  Hydraulic power,  $P_h$  / pump efficiency,  $\eta_{\text{pump}}$**

**Electrical input power =  $\frac{\text{Pump shaft power } P_s}{\eta_{\text{Motor}}}$**

### **1.20.2 Centrifugal Pumps**

A centrifugal pump converts input power to kinetic energy by accelerating liquid in a revolving device - an impeller.

The most common is the volute pump - where fluid enters the pump through the eye of the impeller which rotates at high speed. The fluid accelerates radially outward from the pump chasing and a vacuum is created at the impellers eye that continuously draws more fluid into the pump.

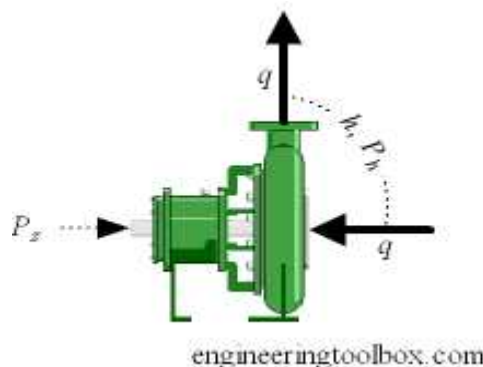

The energy from the pumps prime mover is transferred to kinetic energy according to the Bernoulli Equation. The energy transferred to the liquid corresponds to the velocity at the edge or vane tip of the impeller. The faster the impeller revolves or the bigger the impeller is, the higher will the velocity of the liquid energy transferred to the liquid be. This is described by the Affinity Laws.

## Pressure and Head

If the discharge of a centrifugal pump is pointed straight up into the air the fluid will be pumped to a certain height - or head - called the **shut off head**. This maximum head is mainly determined by the outside diameter of the pump's impeller and the speed of the rotating shaft. The head will change as the capacity of the pump is altered.

The kinetic energy of a liquid coming out of an impeller is obstructed by creating a **resistance** in the flow. The first resistance is created by the pump casing which catches the liquid and slows it down. When the liquid slows down the kinetic energy is converted to pressure energy.

- it is the resistance to the pump's flow that is read on a pressure gauge attached to the discharge line

A pump does not create pressure, it only creates flow. The gauge pressure is a measurement of the resistance to flow.

In fluids the term **head** is used to measure the kinetic energy which a pump creates. Head is a measurement of the height of the liquid column the pump could create from the kinetic energy the pump gives to the liquid.

- the main reason for using head instead of pressure to measure a centrifugal pump's energy is that the pressure from a pump will change if the specific gravity (weight) of the liquid changes, but the head will not

The pump's performance on any Newtonian fluid can always be described by using the term head.

### *Different Types of Pump Head*

- Total Static Head - Total head when the pump is not running
- Total Dynamic Head (Total System Head) - Total head when the pump is running
- Static Suction Head - Head on the suction side, with pump off, if the head is higher than the pump impeller
- Static Suction Lift - Head on the suction side, with pump off, if the head is lower than the pump impeller
- Static Discharge Head - Head on discharge side of pump with the pump off
- Dynamic Suction Head/Lift - Head on suction side of pump with pump on
- Dynamic Discharge Head - Head on discharge side of pump with pump on

The head is measured in either feet or meters and can be converted to common units for pressure - like psi, Pa or bar.

- it is important to understand that the pump will pump all fluids to the same height if the shaft is turning at the same rpm

The only difference between the fluids is the amount of power it takes to get the shaft to the proper rpm. The higher the specific gravity of the fluid the more power is required.

- Centrifugal Pumps are "**constant head machines**"

Note that the latter is not a constant pressure machine, since pressure is a function of head and density. The head is constant, even if the density (and therefore pressure) changes.

The head of a pump can be expressed in metric units as:

$$h = (p_2 - p_1) / (\rho g) + v_2^2 / (2 g) \quad (1)$$

where

$h$  = total head developed (m)

$p_2$  = pressure at outlet ( $N/m^2$ )

$p_1$  = pressure at inlet ( $N/m^2$ )

$\rho$  = density ( $kg/m^3$ )

$g$  = acceleration of gravity (9.81)  $m/s^2$

$v_2$  = velocity at the outlet (m/s)

Head described in simple terms

- a pump's vertical discharge "pressure-head" is the vertical lift in height - usually measured in feet or m of water - at which a pump can no longer exert enough pressure to move water. At this point, the pump may be said to have reached its "shut-off" head pressure. In the flow curve chart for a pump the "shut-off head" is the point on the graph where the flow rate is zero

Pump Efficiency

Pump efficiency, (%) is a measure of the efficiency with which the pump transfers useful work to the fluid.

$$\eta = P_{out} / P_{in} \quad (2)$$

where

$\eta$  = efficiency (%)

$P_{in}$  = power input

$P_{out}$  = power output

## Centrifugal Pumps - Speed Torque Curve

### Centrifugal pumps and the characteristic speed torque curve

The speed torque curve characterizes a centrifugal pump. The theoretical characteristic is a parabola starting from the origin and proportional to the square of the speed.

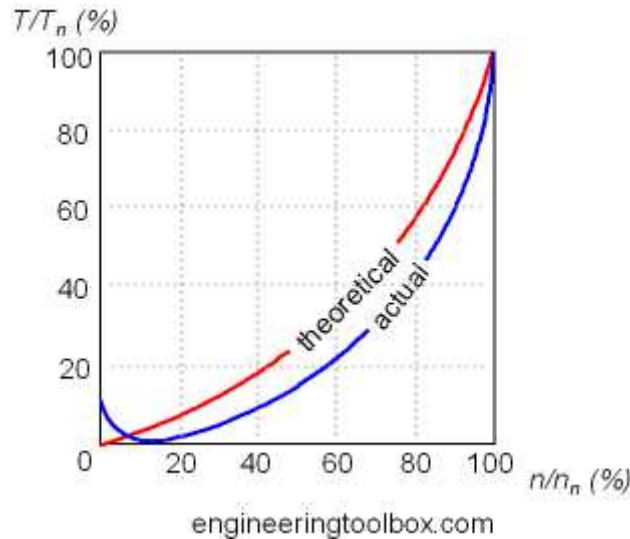

The torque can be expressed as

$$T = k n^2 \quad (1)$$

where

$T = \text{torque (Nm, lb}_f\text{ft)}$

$k = \text{constant}$

$n = \text{pump speed or velocity (rpm)}$

With the discharge valve closed the torque amounts to 30 - 50 % of the nominal torque at full speed.

Full Load Torque

The torque at full load can be calculated as

$$T = 30 P / ( n) \quad (2)$$

where

$T = \text{torque (kN m)}$

$P = \text{power (kW)}$

### 1.20.3 Positive Displacement Pumps

A Positive Displacement Pump has an expanding cavity on the suction side and a decreasing cavity on the discharge side. Liquid flows into the pumps as the cavity on the suction side expands and the liquid flows out of the discharge as the cavity collapses. The volume is a constant given each cycle of operation.

The positive displacement pumps can be divided in two main classes

- reciprocating
- rotary

The positive displacement principle applies whether the pump is a

- rotary lobe pump
- progressing cavity pump
- rotary gear pump
- piston pump
- diaphragm pump
- screw pump
- gear pump
- vane pump
- regenerative (peripheral) pump
- peristaltic

A Positive Displacement Pump, unlike a Centrifugal or Roto-dynamic Pump, will produce the same flow at a given speed (RPM) no matter the discharge pressure.

- A Positive Displacement Pumps is a "**constant flow machine**"

A Positive Displacement Pump must never operate against closed valves on the discharge side of the pump - it has no shut-off head like Centrifugal Pumps. A Positive Displacement Pump operating against closed discharge valves continues to produce flow until the pressure in the discharge line is increased until the line bursts or the pump is severely damaged - or both.

A **relief or safety valve** on the discharge side of the Positive Displacement Pump is **absolute necessary**. The relief valve can be internal or external the pump. An internal valve should in general only be used as a safety precaution. An external relief valve installed in the discharge line with a return line back to the suction line or supply tank is highly recommended.

## **Reciprocating Pumps**

Typical reciprocating pumps are

- plunger pumps
- diaphragm pumps

Plunger pumps consists of a cylinder with a reciprocating plunger in it. In the head of the cylinder the suction and discharge valves are mounted. In the suction stroke the plunger retracts and the suction valves opens causing suction of fluid into the cylinder. In the forward stroke the plunger push the liquid out the discharge valve.

With only one cylinder the fluid flow varies between maximum flow when the plunger moves through the middle positions, and zero flow when the plunger is in the end positions. A lot of energy is wasted when the fluid is accelerated in the piping system. Vibration and "water hammers" may be a serious problem. In general the problems are compensated by using two or more cylinders not working in phase with each other.



In a diaphragm pump the plunger pressurizes hydraulic oil which is used to flex a diaphragm in the pumping cylinder. Diaphragm pumps are used to pump hazardous and toxic fluids.

## Rotary Pumps

Typical rotary pumps are

- gear pumps
- lobe pumps
- vane pumps
- progressive cavity pumps
- peripheral pumps
- screw pumps

In a gear pump the liquid is trapped by the opening between the gear teeth of two identical gears and the casing of the pump on the suction side. On the pressure side the fluid is squeezed out when the teeth of the two gears are rotated against each other.

A lobe pump operates similar to a gear pump, but with two lobes driven by external timing gears. The lobes do not make contact.

A progressive cavity pump consist of a metal rotor rotating within an elastomer-lined or elastic stator. When the rotor turns progressive chambers from suction end to discharge end are formed between the rotor and stator, moving the fluid.

## 1.21 Fans, blowers, compressed air systems:

### 1.21.0 Introduction

#### Fans

- A Fan is a machine used to move fluid or air. It is operated through a motor via electricity which rotates the blades that are attached to a shaft.

#### Blowers

- A blower is a machine for moving volumes of a gas with **moderate increase of pressure**

#### Compressors

- A compressor is a machine for raising a gas - a **compressible** fluid - to a higher level of pressure

Fans and blowers provide air for ventilation and industrial process requirements. Fans generate a pressure to move air (or gases) against a resistance caused by ducts, dampers, or other components in a fan system. The fan rotor receives energy from a rotating shaft and transmits it to the air.

Difference between Fans, Blowers and Compressors Fans, blowers and compressors are differentiated by the method used to move the air, and by the system pressure they must operate against. As per American Society of Mechanical Engineers (ASME) the specific ratio - the

ratio of the discharge pressure over the suction pressure – is used for defining the fans, blowers and compressors (see Table 5.1).

<b>TABLE 5.1 DIFFERENCES BETWEEN FANS, BLOWER AND COMPRESSOR</b>		
<b>Equipment</b>	<b>Specific Ratio</b>	<b>Pressure rise (mmWg)</b>
Fans	Up to 1.11	1136
Blowers	1.11 to 1.20	1136 – 2066
Compressors	more than 1.20	–

### 1.21.1 Fan Types

Fan and blower selection depends on the volume flow rate, pressure, type of material handled, space limitations, and efficiency. Fan efficiencies differ from design to design and also by types. Typical ranges of fan efficiencies are given in Table 5.2.

**Fans fall into two general categories:** centrifugal flow and axial flow.

In centrifugal flow, airflow changes direction twice - once when entering and second when leaving (forward curved, backward curved or inclined, radial) (see Figure 5.1).

In axial flow, air enters and leaves the fan with no change in direction (propeller, tubeaxial, vaneaxial) (see Figure 5.2).

Depending on their designs, the following are main types of fans:

- **Centrifugal fans:** In this type of fan, airflow changes direction. They can be inclined, radial, forward curved, backward curved etc. These kinds of fans are suitable for high temperatures and low and medium blade tip speeds at high pressures. These can be effectively used for highly contaminated airstreams.
- **Axial Fans:** In this type of fan, there is no change in direction of air flow. They can be Vanaxial, Tubeaxial, and Propeller. They produce lower pressure than the Centrifugal fans. Propeller-type fans are capable of high-flow rates at low pressures. Tube-axial fans have low/medium pressure and high flow capability. Vane-axial fans have an inlet or outlet guide vanes, exhibit high pressure and medium flow-rate capabilities.

The air flow required in the process along with required outlet pressure are key factors determining the selection of type and size of a fan. Fan enclosure and duct design also determine how efficiently they can work.

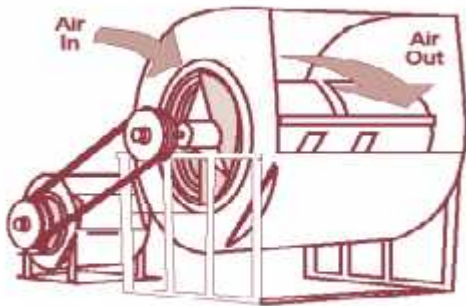

Figure 5.1 Centrifugal Fan

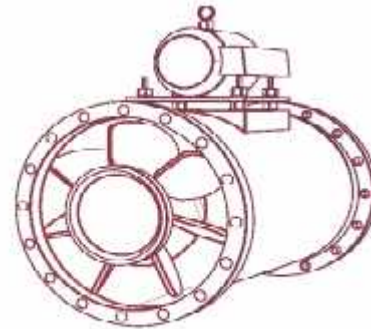

Figure 5.2 Axial Fan

TABLE 5.2 FAN EFFICIENCIES	
Type of fan	Peak Efficiency Range
<b>Centrifugal Fans</b>	
Airfoil, backward curved/inclined	79–83
Modified radial	72–79
Radial	69–75
Pressure blower	58–68
Forward curved	60–65
<b>Axial fan</b>	
Vane axial	78–85
Tube axial	67–72
Propeller	45–50

### Centrifugal Fan: Types

The major types of centrifugal fan are: radial, forward curved and backward curved (see Figure 5.3). Radial fans are industrial workhorses because of their high static pressures (upto 1400 mm WC) and ability to handle heavily contaminated airstreams. Because of their simple design, radial fans are well suited for high temperatures and medium blade tip speeds.

Forward-curved fans are used in clean environments and operate at lower temperatures. They are well suited for low tip speed and high-airflow work - they are best suited for moving large volumes of air against relatively low pressures. Backward-inclined fans are more efficient than forward-curved fans.

Backward-inclined fans reach their peak power consumption and then power demand drops off well within their useable airflow range. Backward-inclined fans are known as "non-overloading" because changes in static pressure do not overload the motor.

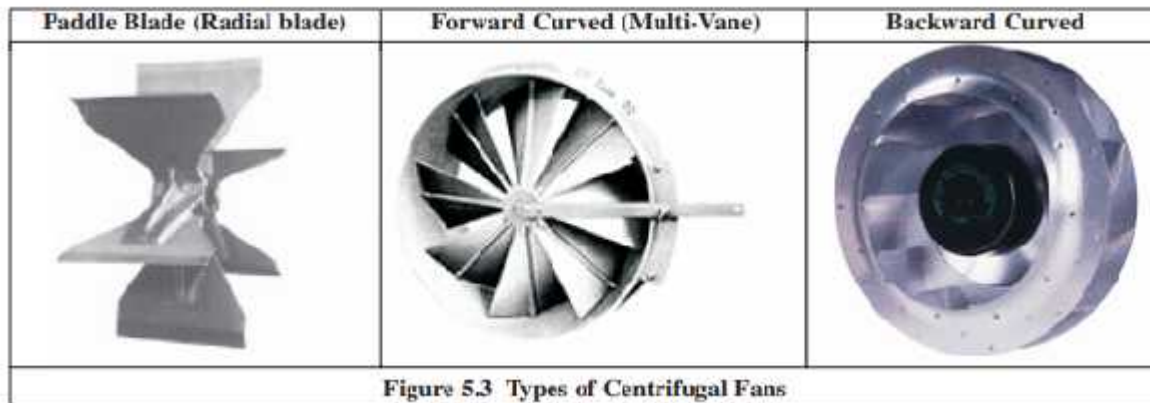

### Axial Flow Fan: Types

The major types of axial flow fans are: tube axial, vane axial and propeller (see Figure 5.4.)

Tubeaxial fans have a wheel inside a cylindrical housing, with close clearance between blade and housing to improve airflow efficiency. The wheel turn faster than propeller fans, enabling operation under high-pressures 250 – 400 mm WC. The efficiency is up to 65%.

Vaneaxial fans are similar to tubeaxials, but with addition of guide vanes that improve efficiency by directing and straightening the flow. As a result, they have a higher static pressure with less dependence on the duct static pressure. Such fans are used generally for pressures upto 500 mmWC. Vaneaxials are typically the most energy-efficient fans available and should be used whenever possible.

Propeller fans usually run at low speeds and moderate temperatures. They experience a large change in airflow with small changes in static pressure. They handle large volumes of air at low pressure or free delivery. Propeller fans are often used indoors as exhaust fans. Outdoor applications include air-cooled condensers and cooling towers. Efficiency is low – approximately 50% or less.

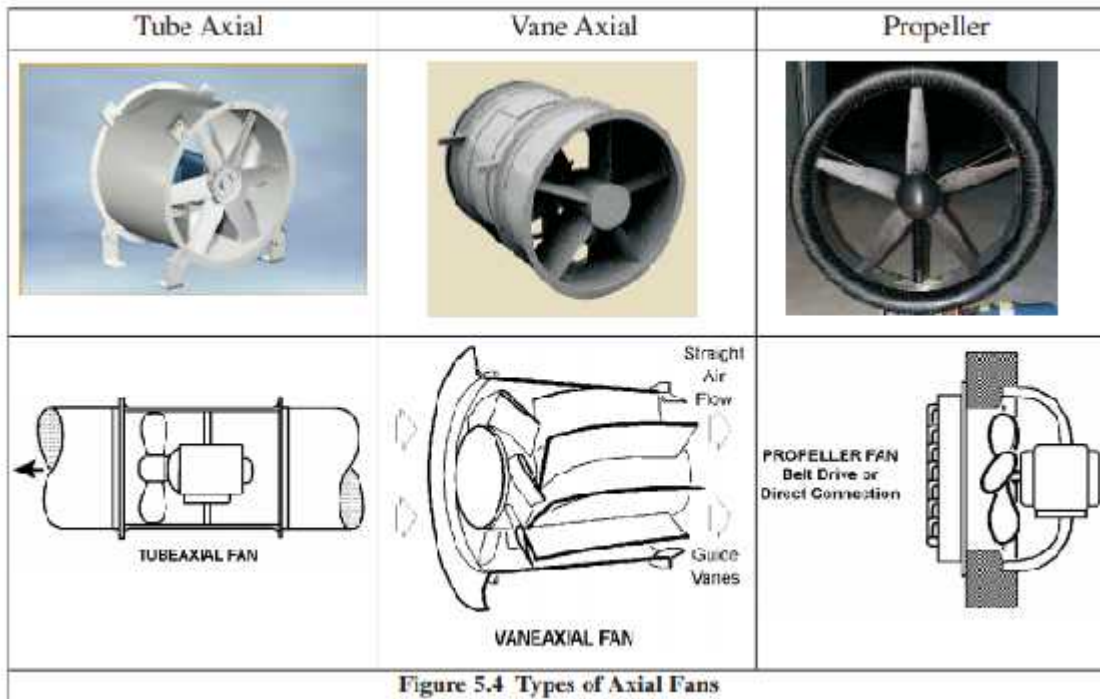

Figure 5.4 Types of Axial Fans

The different types of fans, their characteristics and typical applications are given in Table 5.3.

TABLE 5.3 TYPES OF FANS, CHARACTERISTICS, AND TYPICAL APPLICATIONS					
Centrifugal Fans			Axial-flow Fans		
Type	Characteristics	Typical Applications	Type	Characteristics	Typical Applications
Radial	High pressure, medium flow, efficiency close to tube-axial fans, power increases continuously	Various industrial applications, suitable for dust laden, moist air/gases	Propeller	Low pressure, high flow, low efficiency, peak efficiency close to point of free air delivery (zero static pressure)	Air-circulation, ventilation, exhaust
Forward-curved blades	Medium pressure, high flow, dip in pressure curve, efficiency higher than radial fans, power rises continuously	Low pressure HVAC, packaged units, suitable for clean and dust laden air / gases	Tube-axial	Medium pressure, high flow, higher efficiency than propeller type, dip in pressure-flow curve before peak pressure point.	HVAC, drying ovens, exhaust systems
Backward curved blades	High pressure, high flow, high efficiency, power reduces as flow increases beyond point of highest efficiency	HVAC, various industrial applications forced draft fans, etc.	Vane-axial	High pressure, medium flow, dip in pressure-flow curve, use of guide vanes improves efficiency/exhausts	High pressure applications including HVAC systems,
Airfoil type	Same as backward curved type, highest efficiency	Same as backward curved, but for clean air applications			



## Fan efficiency

Fan manufacturers generally use two ways to mention fan efficiency: mechanical efficiency (sometimes called the total efficiency) and static efficiency. Both measure how well the fan converts horsepower into flow and pressure.

The equation for determining mechanical efficiency is:

$$\text{Fan Mechanical Efficiency } \eta_{\text{mechanical}} \% = \frac{\text{Volume in m}^3/\text{Sec} \times \Delta p \text{ (total pressure) in mmwc}}{102 \times \text{Power input to the fan shaft in (kW)}} \times 100$$

The static efficiency equation is the same except that the outlet velocity pressure is not added to the fan static pressure

$$\text{Fan Static Efficiency } \eta_{\text{static}} \% = \frac{\text{Volume in m}^3/\text{Sec} \times \Delta p \text{ (static pressure) in mmwc}}{102 \times \text{Power input to the fan shaft in (kW)}} \times 100$$

Drive motor kW can be measured by a load analyzer. This kW multiplied by motor efficiency gives the shaft power to the fan.

### 1.21.2 Blowers

Blower is equipment or a device which increases the velocity of air or gas when it is passed through equipped impellers. They are mainly used for flow of air/gas required for exhausting, aspirating, cooling, ventilating, conveying etc. Blower is also commonly known as Centrifugal Fans in industry. In a blower, the inlet pressure is low and is higher at the outlet. The kinetic energy of the blades increases the pressure of the air at the outlet. Blowers are mainly used in industries for moderate pressure requirements where the pressure is more than the fan and less than the compressor.

#### Blower Types

Blowers can achieve much higher pressures than fans, as high as 1.20 kg/cm<sup>2</sup>. They are also used to produce negative pressures for industrial vacuum systems. Major types are: centrifugal blower and positive-displacement blower.

Centrifugal blowers look more like centrifugal pumps than fans. The impeller is typically gear-driven and rotates as fast as 15,000 rpm. In multi-stage blowers, air is accelerated as it passes through each impeller. In single-stage blower, air does not take many turns, and hence it is more efficient.

Centrifugal blowers typically operate against pressures of 0.35 to 0.70 kg/cm<sup>2</sup>, but can achieve higher pressures. One characteristic is that airflow tends to drop drastically as system pressure increases, which can be a disadvantage in material conveying systems that depend on a steady air volume. Because of this, they are most often used in applications that are not prone to clogging.

Positive-displacement blowers have rotors, which "trap" air and push it through housing. Positive-displacement blowers provide a constant volume of air even if the system pressure varies. They are especially suitable for applications prone to clogging, since they can produce enough pressure - typically up to 1.25 kg/cm<sup>2</sup> - to blow clogged materials free. They turn much slower than centrifugal blowers (e.g. 3,600 rpm), and are often belt driven to facilitate speed changes.

### 1.21.3 Compressed air systems

Air compressors are used in a variety of industries to supply process requirements, to operate pneumatic tools and equipment, and to meet instrumentation needs.

#### Types of Compressors

Compressors are broadly classified as: Positive displacement compressor and Dynamic compressor.

**Positive displacement compressors** increase the pressure of the gas by reducing the volume. Positive displacement compressors are further classified as reciprocating and rotary compressors.

**Dynamic compressors** increase the air velocity, which is then converted to increased pressure at the outlet. Dynamic compressors are basically centrifugal compressors and are further classified as radial and axial flow types.

The flow and pressure requirements of a given application determine the suitability of a particular type of compressor.

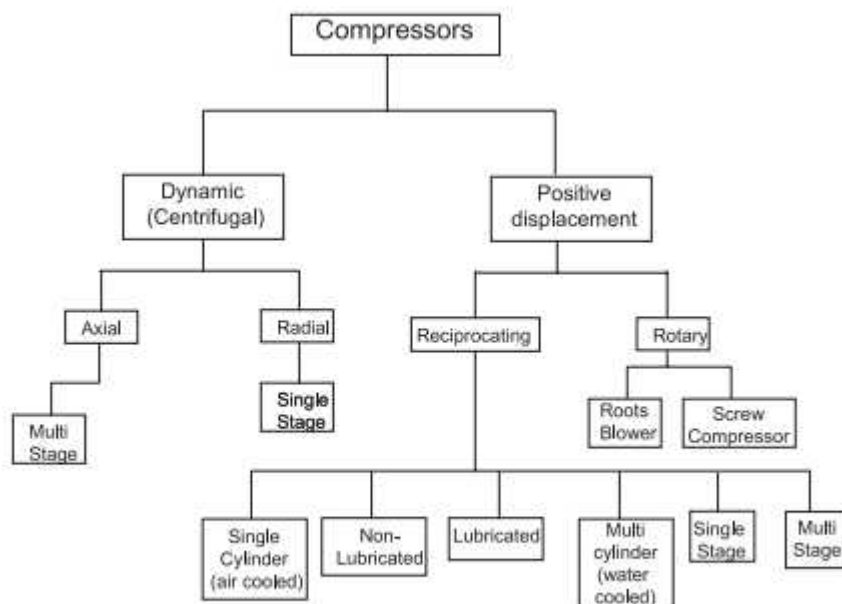

Figure 3.2 Compressor Chart

**Positive displacement compressors** use a system which induces in a volume of air in a chamber, and then reduce the volume of the chamber to compress the air. As the name suggests, there is a displacement of the component that reduces the volume of the chamber thereby compressing air/gas. On the other hand, in a **dynamic compressor**, there is a change in velocity of the fluid resulting in kinetic energy which creates pressure.

Reciprocating compressors use pistons where discharge pressure of air is high, the quantity of air handled is low and which has a low speed of the compressor. They are suitable for medium and high-pressure ratio and gas volumes. On the other hand, rotary compressors are suitable for low and medium pressures and for large volumes. These compressors do not have any

pistons and crankshaft. Instead, these compressors have screws, vanes, scrolls etc. So they can be further categorized on the basis of the component they are equipped with.

### Types of Rotary compressors

- Scroll: In this equipment, air is compressed using two spirals or scrolls. One scroll is fixed and does not move and the other one moves in circular motion. Air gets trapped inside the spiral way of that element and gets compressed at the middle of the spiral. These are often with oil-free designs and require low maintenance.
- Vane: This consists of vanes that move in and out inside an impeller and compression occurs because of this sweeping motion. This forces the vapor into small volume sections, changing it into high pressure and high temperature vapor.
- Lobe: This consists of two lobes which rotate inside a closed casing. These lobes are displaced with 90 degrees to one another. As the rotor rotates, air is drawn into the inlet side of the cylinder casing and is pushed with a force out from the outlet side against the system pressure. The compressed air is then delivered to delivery line.
- Screw: This is equipped with two inter-meshing screws which traps air between the screw and the compressor casing, which results in squeezing and delivering it at a higher pressure from the delivery valve. The screw compressors are suitable and efficient in low air pressure requirements. In comparison to a reciprocating compressor, the compressed air delivery is continuous in this type of compressor and it is quiet in operation.
- Scroll: The scroll type compressors have scrolls driven by the prime mover. The scrolls outer edges trap air and then as they rotate, the air travel from outwards to inwards thus getting compressed due to a reduction in the area. The compressed air is delivered through central space of the scroll to the delivery airline.
- Liquid ring: In this type of compressor vanes are built inside a cylindrical casing. When the motor rotates, gas gets compressed. Then liquid mostly water is fed into the device and by centrifugal acceleration, it forms a liquid ring through the vanes, which in turn forms a compressing chamber. It is capable of compressing all gases and vapors, even with dust and liquids.

### Reciprocating Compressor

- Single-Acting Compressors: It has piston working on air only in one direction. The air is compressed only on the top part of the piston.
- Double-Acting Compressors: It has two sets of suction/intake and delivery valves on both sides of the piston. Both sides of the piston are utilized in compressing the air.

### Dynamic Compressors

The main difference between displacement and dynamic compressors is that a displacement compressor works at a constant flow, whereas a dynamic compressor such as Centrifugal and Axial works at a constant pressure and their performance is affected by external conditions such as changes in inlet temperatures etc. In an axial compressor, the gas or fluid flows parallel to the axis of rotations or axially. It is a rotating compressor that can continuously pressurize gases. The blades of an axial compressor are relatively closer to each other. In a centrifugal compressor, fluid enters from the center of the impeller, and moves outward through the



periphery by guide blades thereby reducing the velocity and increasing pressure. It is also known as a turbo compressor. They are efficient and reliable compressors. However, its compression ratio is lesser than axial compressors. Also, centrifugal compressors are more reliable if API (American petroleum Institute) 617 standards are followed.

<b>TABLE 3.1 GENERAL SELECTION CRITERIA FOR COMPRESSORS</b>				
Type of Compressor	Capacity (m <sup>3</sup> /h)		Pressure (bar)	
	From	To	From	To
Roots blower compressor single stage	100	30000	0.1	1
<b>Reciprocating</b>				
– Single / Two stage	100	12000	0.8	12
– Multi stage	100	12000	12.0	700
<b>Screw</b>				
– Single stage	100	2400	0.8	13
– Two stage	100	2200	0.8	24
<b>Centrifugal</b>	600	300000	0.1	450

## Compressor Performance

### A. Capacity of a Compressor

Capacity of a compressor is the full rated volume of flow of gas compressed and delivered at conditions of total temperature, total pressure, and composition prevailing at the compressor inlet. It sometimes means actual flow rate, rather than rated volume of flow. This also termed as Free Air Delivery (FAD) i.e. air at atmospheric conditions at any specific location. Because the altitude, barometer, and temperature may vary at different localities and at different times, it follows that this term does not mean air under identical or standard conditions.

### B. Compressor Efficiency Definitions

Several different measures of compressor efficiency are commonly used: volumetric efficiency, adiabatic efficiency, isothermal efficiency and mechanical efficiency. Adiabatic and isothermal efficiencies are computed as the isothermal or adiabatic power divided by the actual power consumption. The figure obtained indicates the overall efficiency of compressor and drive motor.

#### Isothermal Efficiency

$$\text{Isothermal Efficiency} = \frac{\text{Isothermal Power}}{\text{Actual measured input power}}$$

$$\begin{aligned} \text{Isothermal power (kW)} &= P_1 \times Q_1 \times \log_e r / 36.7 \\ P_1 &= \text{Absolute intake pressure kg/ cm}^2 \\ P_2 &= \text{Absolute delivery pressure kg/ cm}^2 \\ Q_1 &= \text{Free air delivered m}^3/\text{hr.} \\ r &= \text{Pressure ratio } P_2/P_1 \end{aligned}$$

The calculation of isothermal power does not include power needed to overcome friction and generally gives an efficiency that is lower than adiabatic efficiency. The reported value of efficiency is normally the isothermal efficiency. This is an important consideration when selecting compressors based on reported values of efficiency.

$$\text{Volumetric efficiency} = \frac{\text{Free air delivered (m}^3\text{/min)}}{\text{Compressor displacement (m}^3\text{/min)}} \times 100$$

***Volumetric Efficiency***

$$\text{Compressor Displacement} = \frac{\pi \times D^2 \times L \times S \times \chi \times n}{4}$$

- D = Cylinder bore, metre
- L = Cylinder stroke, metre
- S = Compressor speed rpm
- χ = 1 for single acting and  
2 for double acting cylinders
- n = No. of cylinders

For practical purposes, the most effective guide in comparing compressor efficiencies is the specific power consumption ie kW/volume flow rate , for different compressors that would provide identical duty.

**Compressed Air System Components**

Compressed air systems consist of following major components: Intake air filters, inter-stage coolers, after coolers, air dryers, moisture drain traps, receivers, piping network, filters, regulators and lubricators (see Figure 3.6).

- Intake Air Filters: Prevent dust from entering compressor; Dust causes sticking valves, scoured cylinders, excessive wear etc.
- Inter-stage Coolers: Reduce the temperature of the air before it enters the next stage to reduce the work of compression and increase efficiency. They are normally watercooled.
- After Coolers: The objective is to remove the moisture in the air by reducing the temperature in a water-cooled heat exchanger.
- Air-dryers: The remaining traces of moisture after after-cooler are removed using air dryers, as air for instrument and pneumatic equipment has to be relatively free of any moisture. The moisture is removed by using adsorbents like silica gel /activated carbon, or refrigerant dryers, or heat of compression dryers.
- Moisture Drain Traps: Moisture drain traps are used for removal of moisture in the compressed air. These traps resemble steam traps. Various types of traps used are manual drain cocks, timer based / automatic drain valves etc.
- Receivers: Air receivers are provided as storage and smoothening pulsating air output - reducing pressure variations from the compressor

## 1.22 Refrigeration and air conditioning systems

### 1.22.0 Introduction

The Heating, Ventilation and Air Conditioning (HVAC) and refrigeration system transfers the heat energy from or to the products, or building environment. Energy in form of electricity or heat is used to power mechanical equipment designed to transfer heat from a colder, low-energy level to a warmer, high-energy level

***Refrigeration deals with the transfer of heat from a low temperature level at the heat source to a high temperature level at the heat sink by using a low boiling refrigerant.***

There are several heat transfer loops in refrigeration system as described below:

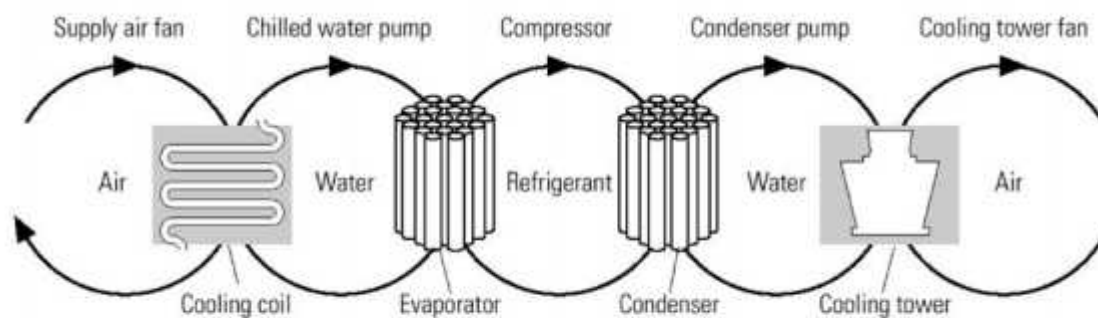

Figure 4.1 Heat Transfer Loops In Refrigeration System

In the Figure 4.1, thermal energy moves from left to right as it is extracted from the space and expelled into the outdoors through five loops of heat transfer:

- Indoor air loop. In the leftmost loop, indoor air is driven by the supply air fan through a cooling coil, where it transfers its heat to chilled water. The cool air then cools the building space.
- Chilled water loop. Driven by the chilled water pump, water returns from the cooling coil to the chiller's evaporator to be re-cooled.
- Refrigerant loop. Using a phase-change refrigerant, the chiller's compressor pumps heat from the chilled water to the condenser water.
- Condenser water loop. Water absorbs heat from the chiller's condenser, and the condenser water pump sends it to the cooling tower.
- Cooling tower loop. The cooling tower's fan drives air across an open flow of the hot condenser water, transferring the heat to the outdoors.

Air-Conditioning Systems Depending on applications, there are several options / combinations, which are available for use as given below:

- Air Conditioning (for comfort / machine)
- Split air conditioners
- Fan coil units in a larger system
- Air handling units in a larger system

## Refrigeration Systems (for processes)

- Small capacity modular units of direct expansion type similar to domestic refrigerators, small capacity refrigeration units.
- Centralized chilled water plants with chilled water as a secondary coolant for temperature range over 5°C typically. They can also be used for ice bank formation.
- Brine plants, which use brines as lower temperature, secondary coolant, for typically sub zero temperature applications, which come as modular unit capacities as well as large centralized plant capacities.
- The plant capacities upto 50 TR are usually considered as small capacity, 50 – 250 TR as medium capacity and over 250 TR as large capacity units.

A large industry may have a bank of such units, often with common chilled water pumps, condenser water pumps, cooling towers, as an off site utility. The same industry may also have two or three levels of refrigeration & air conditioning such as:

- Comfort air conditioning (20° – 25° C)
- Chilled water system (8° – 10° C)
- Brine system (sub-zero applications)

Two principle types of refrigeration plants found in industrial use are: Vapour Compression Refrigeration (VCR) and Vapour Absorption Refrigeration (VAR). VCR uses mechanical energy as the driving force for refrigeration, while VAR uses thermal energy as the driving force for refrigeration.

### 1.22.1 Types of Refrigeration System

#### Vapour Compression Refrigeration

Heat flows naturally from a hot to a colder body. In refrigeration system the opposite must occur i.e. heat flows from a cold to a hotter body. This is achieved by using a substance called a refrigerant, which absorbs heat and hence boils or evaporates at a low pressure to form a gas. This gas is then compressed to a higher pressure, such that it transfers the heat it has gained to ambient air or water and turns back (condenses) into a liquid. In this way heat is absorbed, or removed, from a low temperature source and transferred to a higher temperature source. The refrigeration cycle can be broken down into the following stages (see Figure 4.2):

1 – 2 Low pressure liquid refrigerant in the evaporator absorbs heat from its surroundings, usually air, water or some other process liquid. During this process it changes its state from a liquid to a gas, and at the evaporator exit is slightly superheated.

2 – 3 The superheated vapour enters the compressor where its pressure is raised. There will also be a big increase in temperature, because a proportion of the energy input into the compression process is transferred to the refrigerant.

3 – 4 The high pressure superheated gas passes from the compressor into the condenser. The initial part of the cooling process (3 - 3a) desuperheats the gas before it is then turned back into liquid (3a - 3b). The cooling for this process is usually achieved by using air or water. A further reduction in temperature happens in the pipe work and liquid receiver (3b - 4), so that the refrigerant liquid is sub-cooled as it enters the expansion device.

4 – 1 The high-pressure sub-cooled liquid passes through the expansion device, which both reduces its pressure and controls the flow into the evaporator.

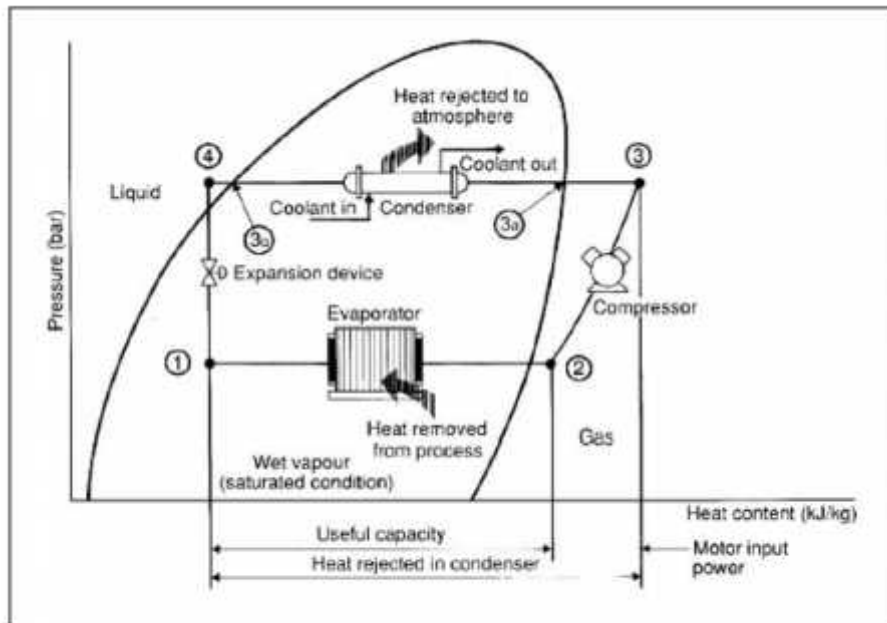

Figure 4.2: Schematic of a Basic Vapor Compression Refrigeration System

It can be seen that the condenser has to be capable of rejecting the combined heat inputs of the evaporator and the compressor; i.e.  $(1 - 2) + (2 - 3)$  has to be the same as  $(3 - 4)$ . There is no heat loss or gain through the expansion device.

## 1.23 DG SET SYSTEM

### 1.23.0 Introduction

Diesel engine is the prime mover, which drives an alternator to produce electrical energy. In the diesel engine, air is drawn into the cylinder and is compressed to a high ratio (14:1 to 25:1). During this compression, the air is heated to a temperature of 700–900°C. A metered quantity of diesel fuel is then injected into the cylinder, which ignites spontaneously because of the high temperature. Hence, the diesel engine is also known as compression ignition (CI) engine.

DG set can be classified according to cycle type as: two stroke and four stroke. However, the bulk of IC engines use the four stroke cycle. Let us look at the principle of operation of the four-stroke diesel engine.

### 1.23.1 Four Stroke - Diesel Engine

The 4 stroke operations in a diesel engine are: induction stroke, compression stroke, ignition and power stroke and exhaust stroke.

**1st:** Induction stroke - while the inlet valve is open, the descending piston draws in fresh air.

**2nd:** Compression stroke - while the valves are closed, the air is compressed to a pressure of up to 25 bar.

**3rd:** Ignition and power stroke - fuel is injected, while the valves are closed (fuel injection actually starts at the end of the previous stroke), the fuel ignites spontaneously and the piston is forced downwards by the combustion gases.

**4th:** Exhaust stroke - the exhaust valve is open and the rising piston discharges the spent gases from the cylinder.

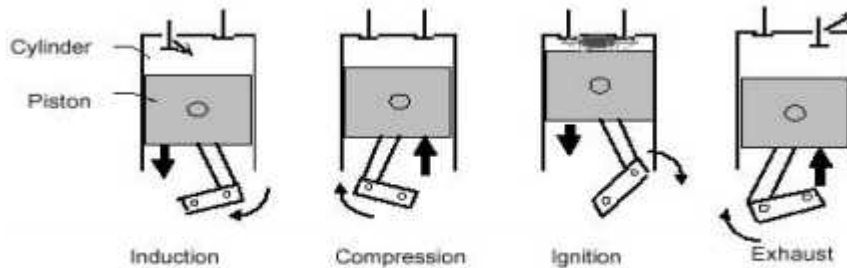

**Figure 9.1 Schematic Diagram of Four-Stroke Diesel Engine**

Since power is developed during only one stroke, the single cylinder four-stroke engine has a low degree of uniformity. Smoother running is obtained with multi cylinder engines because the cranks are staggered in relation to one another on the crankshaft. There are many variations of engine configuration, for example. 4 or 6 cylinder, in-line, horizontally opposed, vee or radial configurations.

### **1.23.2 DG Set as a System**

A diesel generating set should be considered as a system since its successful operation depends on the well-matched performance of the components, namely:

- a) The diesel engine and its accessories.
- b) The AC Generator.
- c) The control systems and switchgear.
- d) The foundation and power house civil works.
- e) The connected load with its own components like heating, motor drives, lighting etc.

It is necessary to select the components with highest efficiency and operate them at their optimum efficiency levels to conserve energy in this system.



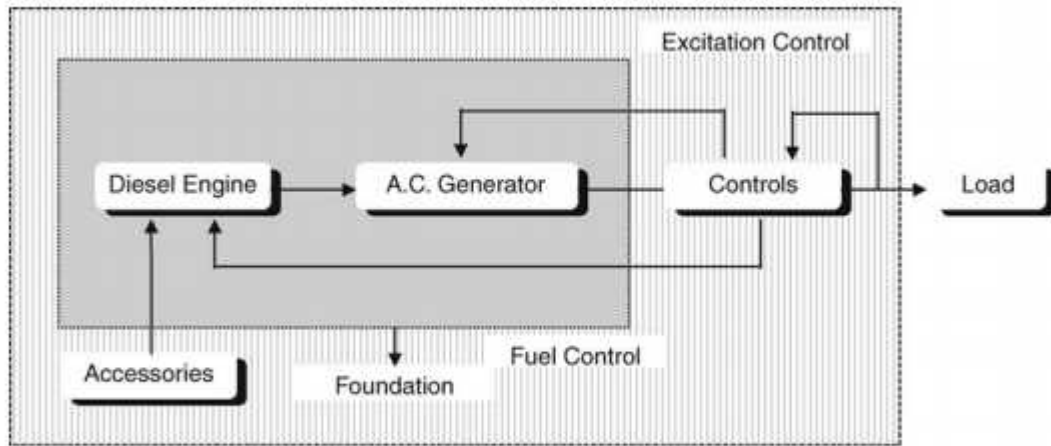

Fig 9.2 DG Set System

## 1.24 Power Factor Improvement and Benefits

### 1.24.0 Power factor Basics

In all industrial electrical distribution systems, the major loads are resistive and inductive. Resistive loads are incandescent lighting and resistance heating. In case of pure resistive loads, the voltage (V), current (I), resistance (R) relations are linearly related, i.e.

$$V = I \times R \text{ and Power (kW)} = V \times I$$

Typical inductive loads are A.C. Motors, induction furnaces, transformers and ballast-type lighting. Inductive loads require two kinds of power: a) active (or working) power to perform the work and b) reactive power to create and maintain electro-magnetic fields.

Active power is measured in kW (Kilo Watts). Reactive power is measured in kVAr (Kilo Volt-Amperes Reactive).

The vector sum of the active power and reactive power make up the total (or apparent) power used. This is the power generated by the SEBs for the user to perform a given amount of work. Total Power is measured in kVA (Kilo Volts-Amperes) (See Figure 1.6).

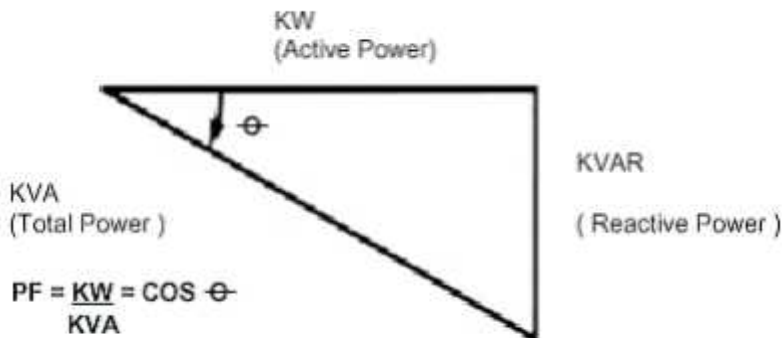

Figure 1.6 kW, kVAr and kVA Vector

The active power (shaft power required or true power required) in kW and the reactive power required (kVAr) are 90° apart vectorically in a pure inductive circuit i.e., reactive power kVAr lagging the active kW. The vector sum of the two is called the apparent power or kVA, as illustrated above and the kVA reflects the actual electrical load on distribution system.

The ratio of kW to kVA is called the power factor, which is always less than or equal to unity. Theoretically, when electric utilities supply power, if all loads have unity power factor, maximum power can be transferred for the same distribution system capacity. However, as the loads are inductive in nature, with the power factor ranging from 0.2 to 0.9, the electrical distribution network is stressed for capacity at low power factors.

### 1.4.1 Improving Power Factor

The solution to improve the power factor is to add power factor correction capacitors (see Figure 1.7) to the plant power distribution system. They act as reactive power generators, and provide the needed reactive power to accomplish kW of work. This reduces the amount of reactive power, and thus total power, generated by the utilities.

#### Example:

A chemical industry had installed a 1500 kVA transformer. The initial demand of the plant was 1160 kVA with power factor of 0.70. The % loading of transformer was about 78% ( $1160/1500 = 77.3\%$ ). To improve the power factor and to avoid the penalty, the unit had added about 410 kVAr in motor load end. This improved the power factor to 0.89, and reduced the required kVA to 913, which is the vector sum of kW and kVAr (see Figure 1.8).

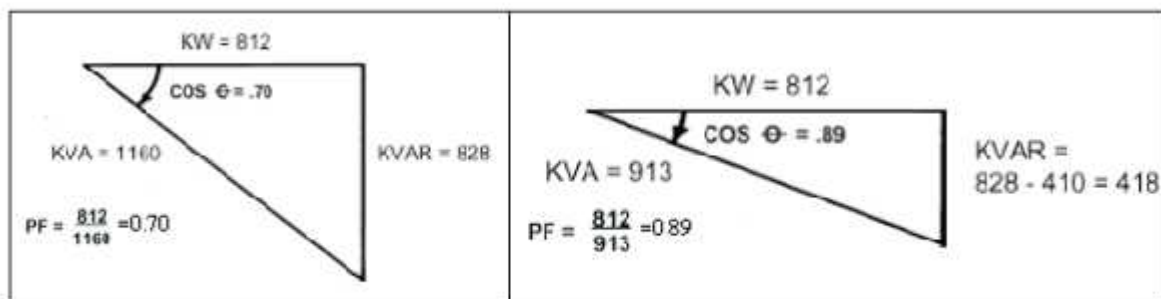

Figure 1.8 Power factor before and after Improvement

After improvement the plant had avoided penalty and the 1500 kVA transformer now loaded only to 60% of capacity. This will allow the addition of more load in the future to be supplied by the transformer.

### 1.24.2 The advantages of PF improvement by capacitor addition

- a) Reactive component of the network is reduced and so also the total current in the system from the source end.
- b)  $I^2 R$  power losses are reduced in the system because of reduction in current.
- c) Voltage level at the load end is increased.



d) kVA loading on the source generators as also on the transformers and lines upto the capacitors reduces giving capacity relief. A high power factor can help in utilising the full capacity of your electrical system.

### 1.24.3 Cost benefits of PF improvement

While costs of PF improvement are in terms of investment needs for capacitor addition the benefits to be quantified for feasibility analysis are:

- a) Reduced kVA (Maximum demand) charges in utility bill
- b) Reduced distribution losses (KWH) within the plant network
- c) Better voltage at motor terminals and improved performance of motors
- d) A high power factor eliminates penalty charges imposed when operating with a low power factor
- e) Investment on system facilities such as transformers, cables, switchgears etc for delivering load is reduced.

### 1.24.5 Selection and location of capacitors

#### Direct relation for capacitor sizing.

$$\text{kVAr Rating} = \text{kW} [\tan^{-1} - \tan^{-2}]$$

where kVAr rating is the size of the capacitor needed, kW is the average power drawn,  $\tan^{-1}$  is the trigonometric ratio for the present power factor, and  $\tan^{-2}$  is the trigonometric ratio for the desired PF.

$$\tan^{-1} = \text{Existing (Cos-1 PF1)} \text{ and } \tan^{-2} = \text{Improved (Cos-1 PF2)}$$

#### Alternatively the Table 1.2 can be used for capacitor sizing.

The figures given in table are the multiplication factors which are to be multiplied with the input power (kW) to give the kVAr of capacitance required to improve present power factor to a new desired power factor.

TABLE 1.2 MULTIPLIERS TO DETERMINE CAPACITOR kVAR REQUIREMENTS FOR POWER FACTOR CORRECTION																					
Original Power Factor	Desired Power Factor																				
	0.90	0.91	0.92	0.93	0.94	0.95	0.96	0.97	0.98	0.99	0.90	0.91	0.92	0.93	0.94	0.95	0.96	0.97	0.98	0.99	1.00
0.50	0.987	1.008	1.034	1.060	1.086	1.112	1.139	1.165	1.192	1.220	1.248	1.276	1.306	1.337	1.369	1.403	1.440	1.481	1.529	1.589	1.732
0.51	0.937	0.962	0.989	1.015	1.041	1.067	1.094	1.120	1.147	1.175	1.203	1.231	1.261	1.290	1.324	1.359	1.395	1.436	1.484	1.544	1.687
0.52	0.893	0.919	0.945	0.971	0.997	1.023	1.050	1.078	1.105	1.131	1.159	1.187	1.217	1.248	1.280	1.314	1.351	1.392	1.440	1.500	1.643
0.53	0.850	0.876	0.902	0.929	0.954	0.980	1.007	1.033	1.060	1.088	1.116	1.144	1.174	1.205	1.237	1.271	1.308	1.349	1.397	1.457	1.600
0.54	0.808	0.835	0.861	0.887	0.913	0.939	0.966	0.992	1.019	1.047	1.075	1.103	1.133	1.164	1.196	1.230	1.267	1.308	1.356	1.416	1.559
0.55	0.769	0.795	0.821	0.847	0.873	0.899	0.926	0.952	0.979	1.007	1.036	1.063	1.093	1.124	1.156	1.190	1.227	1.268	1.316	1.376	1.519
0.56	0.730	0.756	0.782	0.808	0.834	0.860	0.887	0.913	0.940	0.968	0.996	1.024	1.054	1.085	1.117	1.151	1.188	1.229	1.277	1.337	1.480
0.57	0.692	0.719	0.744	0.770	0.796	0.822	0.849	0.875	0.902	0.930	0.958	0.986	1.016	1.047	1.079	1.113	1.150	1.191	1.239	1.299	1.442
0.58	0.655	0.681	0.707	0.733	0.759	0.785	0.812	0.838	0.865	0.893	0.921	0.949	0.979	1.010	1.042	1.076	1.113	1.154	1.202	1.262	1.405
0.59	0.619	0.645	0.671	0.697	0.723	0.749	0.776	0.802	0.829	0.857	0.885	0.913	0.943	0.974	1.006	1.040	1.077	1.118	1.166	1.226	1.369
0.60	0.583	0.609	0.635	0.661	0.687	0.713	0.740	0.766	0.793	0.821	0.849	0.877	0.907	0.938	0.970	1.004	1.041	1.082	1.130	1.190	1.333
0.61	0.549	0.575	0.601	0.627	0.653	0.679	0.706	0.732	0.759	0.787	0.815	0.843	0.873	0.904	0.936	0.970	1.007	1.048	1.096	1.156	1.299
0.62	0.516	0.542	0.568	0.594	0.620	0.646	0.673	0.699	0.726	0.754	0.782	0.810	0.840	0.871	0.903	0.937	0.974	1.015	1.063	1.123	1.266
0.63	0.483	0.509	0.535	0.561	0.587	0.613	0.640	0.666	0.693	0.721	0.749	0.777	0.807	0.838	0.870	0.904	0.941	0.982	1.030	1.090	1.233
0.64	0.451	0.474	0.503	0.529	0.555	0.581	0.608	0.634	0.661	0.689	0.717	0.745	0.775	0.806	0.838	0.872	0.909	0.950	1.000	1.060	1.203
0.65	0.419	0.444	0.471	0.497	0.523	0.549	0.576	0.602	0.629	0.657	0.685	0.713	0.743	0.774	0.806	0.840	0.877	0.918	0.966	1.026	1.169
0.66	0.388	0.414	0.440	0.466	0.492	0.518	0.545	0.571	0.598	0.626	0.654	0.682	0.712	0.743	0.775	0.809	0.846	0.887	0.935	0.995	1.138
0.67	0.358	0.384	0.410	0.436	0.462	0.488	0.515	0.541	0.568	0.596	0.624	0.652	0.682	0.713	0.745	0.779	0.816	0.857	0.905	0.965	1.108
0.68	0.329	0.354	0.380	0.406	0.432	0.458	0.485	0.511	0.538	0.566	0.594	0.622	0.652	0.683	0.715	0.749	0.786	0.827	0.875	0.935	1.078
0.69	0.299	0.325	0.351	0.377	0.403	0.429	0.456	0.482	0.509	0.537	0.565	0.593	0.623	0.654	0.686	0.720	0.757	0.798	0.846	0.906	1.049
0.70	0.270	0.296	0.322	0.348	0.374	0.400	0.427	0.453	0.480	0.508	0.536	0.564	0.594	0.625	0.657	0.691	0.729	0.789	0.847	0.907	1.050
0.71	0.242	0.268	0.294	0.320	0.346	0.372	0.399	0.425	0.452	0.480	0.508	0.536	0.566	0.597	0.629	0.663	0.700	0.741	0.789	0.849	0.992
0.72	0.214	0.240	0.266	0.292	0.318	0.344	0.371	0.397	0.424	0.452	0.480	0.508	0.538	0.569	0.601	0.635	0.672	0.713	0.761	0.821	0.964
0.73	0.186	0.212	0.238	0.264	0.290	0.316	0.343	0.369	0.396	0.424	0.452	0.480	0.510	0.541	0.573	0.607	0.644	0.685	0.733	0.793	0.936
0.74	0.159	0.185	0.211	0.237	0.263	0.289	0.316	0.342	0.369	0.397	0.425	0.453	0.483	0.514	0.546	0.580	0.617	0.658	0.706	0.766	0.909
0.75	0.132	0.158	0.184	0.210	0.236	0.262	0.289	0.315	0.342	0.370	0.398	0.426	0.456	0.487	0.519	0.553	0.589	0.631	0.679	0.739	0.882
0.76	0.106	0.131	0.157	0.183	0.209	0.235	0.262	0.288	0.315	0.343	0.371	0.399	0.429	0.460	0.492	0.526	0.563	0.604	0.652	0.712	0.855
0.77	0.079	0.105	0.131	0.157	0.183	0.209	0.236	0.262	0.289	0.317	0.345	0.373	0.403	0.434	0.466	0.500	0.537	0.578	0.626	0.685	0.828
0.78	0.052	0.078	0.104	0.130	0.156	0.182	0.209	0.235	0.262	0.290	0.318	0.346	0.376	0.407	0.439	0.473	0.510	0.551	0.599	0.658	0.801
0.79	0.026	0.052	0.078	0.104	0.130	0.156	0.183	0.209	0.236	0.264	0.292	0.320	0.350	0.381	0.413	0.447	0.484	0.525	0.573	0.633	0.776
0.80	0.000	0.026	0.052	0.078	0.104	0.130	0.157	0.183	0.210	0.238	0.266	0.294	0.324	0.355	0.387	0.421	0.458	0.499	0.547	0.609	0.752
0.81	0.000	0.028	0.052	0.078	0.104	0.131	0.157	0.184	0.212	0.240	0.268	0.298	0.329	0.361	0.395	0.432	0.473	0.521	0.581	0.641	0.784
0.82	0.000	0.025	0.052	0.078	0.105	0.131	0.158	0.186	0.214	0.242	0.272	0.303	0.335	0.369	0.406	0.447	0.493	0.545	0.605	0.665	0.808
0.83	0.000	0.026	0.052	0.079	0.105	0.132	0.160	0.188	0.216	0.246	0.277	0.309	0.343	0.380	0.421	0.469	0.529	0.591	0.651	0.711	0.854
0.84	0.000	0.025	0.053	0.079	0.106	0.134	0.162	0.190	0.220	0.251	0.283	0.317	0.354	0.395	0.443	0.503	0.564	0.624	0.684	0.744	0.887
0.85	0.000	0.027	0.053	0.080	0.108	0.136	0.164	0.194	0.225	0.257	0.291	0.328	0.369	0.417	0.477	0.537	0.597	0.657	0.717	0.777	0.920
0.86	0.000	0.026	0.053	0.081	0.109	0.137	0.167	0.198	0.230	0.264	0.301	0.342	0.389	0.450	0.510	0.570	0.630	0.690	0.750	0.810	0.953
0.87	0.000	0.027	0.055	0.083	0.111	0.141	0.172	0.204	0.238	0.275	0.316	0.364	0.419	0.480	0.540	0.600	0.660	0.720	0.780	0.840	0.983
0.88	0.000	0.028	0.056	0.084	0.114	0.146	0.177	0.211	0.248	0.289	0.337	0.393	0.450	0.507	0.564	0.621	0.678	0.735	0.792	0.850	0.993
0.89	0.000	0.028	0.056	0.086	0.117	0.149	0.183	0.220	0.261	0.309	0.364	0.420	0.477	0.534	0.591	0.648	0.705	0.762	0.819	0.876	1.019
0.90	0.000	0.028	0.058	0.089	0.121	0.155	0.192	0.233	0.281	0.341	0.401	0.461	0.521	0.581	0.641	0.701	0.761	0.821	0.881	0.941	1.084
0.91	0.000	0.030	0.061	0.093	0.127	0.164	0.205	0.253	0.313	0.373	0.433	0.493	0.553	0.613	0.673	0.733	0.793	0.853	0.913	0.973	1.116
0.92	0.000	0.031	0.063	0.097	0.134	0.175	0.223	0.283	0.343	0.403	0.463	0.523	0.583	0.643	0.703	0.763	0.823	0.883	0.943	1.003	1.146
0.93	0.000	0.032	0.065	0.103	0.144	0.192	0.242	0.292	0.352	0.412	0.472	0.532	0.592	0.652	0.712	0.772	0.832	0.892	0.952	1.012	1.155
0.94	0.000	0.034	0.071	0.112	0.160	0.210	0.260	0.310	0.360	0.410	0.460	0.510	0.560	0.610	0.660	0.710	0.760	0.810	0.860	0.910	1.053
0.95	0.000	0.037	0.079	0.126	0.186	0.246	0.306	0.366	0.426	0.486	0.546	0.606	0.666	0.726	0.786	0.846	0.906	0.966	1.026	1.086	1.229
0.96	0.000	0.041	0.089	0.140	0.200	0.260	0.320	0.380	0.440	0.500	0.560	0.620	0.680	0.740	0.800	0.860	0.920	0.980	1.040	1.100	1.243
0.97	0.000	0.048	0.108	0.168	0.228	0.288	0.348	0.408	0.468	0.528	0.588	0.648	0.708	0.768	0.828	0.888	0.948	1.008	1.068	1.128	1.271
0.98	0.000	0.060	0.160	0.260	0.360	0.460	0.560	0.660	0.760	0.860	0.960	1.060	1.160	1.260	1.360	1.460	1.560	1.660	1.760	1.860	2.003
0.99	0.000	0.143	0.243	0.343	0.443	0.543	0.643	0.743	0.843	0.943	1.043	1.143	1.243	1.343	1.443	1.543	1.643	1.743	1.843	1.943	2.086
1.00	0.000	0.000	0.000	0.000	0.000	0.000	0.000	0.000	0.000	0.000	0.000	0.000	0.000	0.000	0.000	0.000	0.000	0.000	0.000	0.000	0.000

**Example:**

The utility bill shows an average power factor of 0.72 with an average KW of 627. How much kVAR is required to improve the power factor to .95 ?

**Using formula**

$$\cos^{-1} 0.72, \tan^{-1} 0.963 \quad \cos^{-1} 0.95, \tan^{-1} 0.329 \quad \text{kVAR required} = P (\tan^{-1} 0.963 - \tan^{-1} 0.329) = 627 (0.964 - 0.329) = 398 \text{ kVAR}$$

**Using table (see Table 1.2)**

- 1) Locate 0.72 (original power factor) in column (1).
- 2) Read across desired power factor to 0.95 column. We find 0.635 multiplier
- 3) Multiply 627 (average kW) by 0.635 = 398 kVAR.
- 4) Install 400 kVAR to improve power factor to 95%.

### 1.24.6 Location of Capacitors

The primary purpose of capacitors is to reduce the maximum demand. Additional benefits are derived by capacitor location. The Figure 1.9 indicates typical capacitor locations. Maximum benefit of capacitors is derived by locating them as close as possible to the load. At this location, its kVAR are confined to the smallest possible segment, decreasing the load current. This, in turn, will reduce power losses of the system substantially. Power losses are proportional to the square of the current. When power losses are reduced, voltage at the motor increases; thus, motor performance also increases. Locations C1A, C1B and C1C of Figure 1.9 indicate three different arrangements at the load. Note that in all three locations extra switches are not required, since the capacitor is either switched with the motor starter or the breaker before the starter. Case C1A is recommended for new installation, since the maximum benefit is derived and the size of the motor thermal protector is reduced. In Case C1B, as in Case C1A, the capacitor is energized only when the motor is in operation. Case C1B is recommended in cases where the installation already exists and the thermal protector does not need to be re-sized. In position C1C, the capacitor is permanently connected to the circuit but does not require a separate switch, since capacitor can be disconnected by the breaker before the starter.

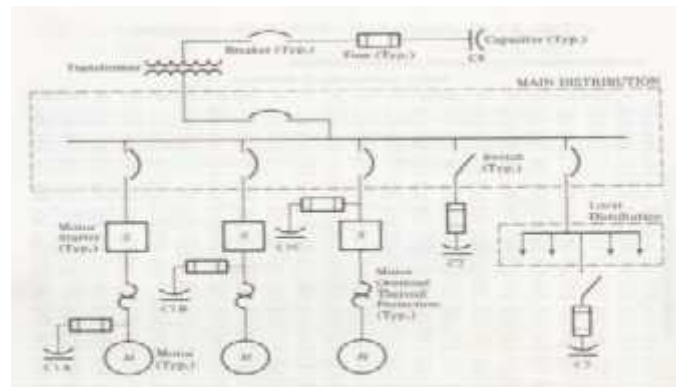

**Figure 1.9: Power Distribution Diagram Illustrating Capacitor Locations**

It should be noted that the rating of the capacitor should not be greater than the no-load magnetizing kVAR of the motor. If this condition exists, damaging over voltage or transient torques can occur. This is why most motor manufacturers specify maximum capacitor ratings to be applied to specific motors.

The next preference for capacitor locations as illustrated by Figure 1.9 is at locations C2 and C3. In these locations, a breaker or switch will be required. Location C4 requires a high voltage breaker. The advantage of locating capacitors at power centres or feeders is that they can be grouped together. When several motors are running intermittently, the capacitors are permitted to be on line all the time, reducing the total power regardless of load.

From energy efficiency point of view, capacitor location at receiving substation only helps the utility in loss reduction. Locating capacitors at tail end will help to reduce loss reduction within the plants distribution network as well and directly benefit the user by reduced consumption. Reduction in the distribution loss % in kWh when tail end power factor is raised from PF1 to a new power factor PF2, will be proportional to

$$\left[ 1 - (PF_1 / PF_2)^2 \right] \times 100$$

### 1.24.7 Capacitors for Other Loads

The other types of load requiring capacitor application include induction furnaces, induction heaters and arc welding transformers etc. The capacitors are normally supplied with control gear for the application of induction furnaces and induction heating furnaces. The PF of arc furnaces experiences a wide variation over melting cycle as it changes from 0.7 at starting to 0.9 at the end of the cycle. Power factor for welding transformers is corrected by connecting capacitors across the primary winding of the transformers, as the normal PF would be in the range of 0.35.

### 1.24.8 Performance Assessment of Power Factor Capacitors

#### Voltage effects:

Ideally capacitor voltage rating is to match the supply voltage. If the supply voltage is lower, the reactive kVAr produced will be the ratio  $V_1^2 / V_2^2$  where  $V_1$  is the actual supply voltage,  $V_2$  is the rated voltage. On the other hand, if the supply voltage exceeds rated voltage, the life of the capacitor is adversely affected.

#### Material of capacitors:

Power factor capacitors are available in various types by dielectric material used as; paper/polypropylene etc. The watt loss per kVAr as well as life vary with respect to the choice of the dielectric material and hence is a factor to be considered while selection.

#### Connections:

Shunt capacitor connections are adopted for almost all industry/ end user applications, while series capacitors are adopted for voltage boosting in distribution networks.

#### Operational performance of capacitors:

This can be made by monitoring capacitor charging current vis- a- vis the rated charging current. Capacity of fused elements can be replenished as per requirements. Portable analyzers can be used for measuring kVAr delivered as well as charging current. Capacitors consume 0.2 to 6.0 Watt per kVAr, which is negligible in comparison to benefits.

Some checks that need to be adopted in use of capacitors are :

- i) Nameplates can be misleading with respect to ratings. It is good to check by charging currents.
- ii) Capacitor boxes may contain only insulated compound and insulated terminals with no capacitor elements inside.
- iii) Capacitors for single phase motor starting and those used for lighting circuits for voltage boost, are not power factor capacitor units and these cannot withstand power system conditions.

## 1.25 Harmonics

In any alternating current network, flow of current depends upon the voltage applied and the impedance (resistance to AC) provided by elements like resistances, reactances of inductive and capacitive nature. As the value of impedance in above devices is constant, they are called linear whereby the voltage and current relation is of linear nature. However in real life situation, various devices like diodes, silicon controlled rectifiers, PWM systems, thyristors, voltage & current chopping saturated core reactors, induction & arc furnaces are also deployed for various requirements and due to their varying impedance characteristic, these NON LINEAR devices cause distortion in voltage and current waveforms which is of increasing concern in recent times. Harmonics occurs as spikes at intervals which are multiples of the mains (supply) frequency and these distort the pure sine wave form of the supply voltage & current. Harmonics are multiples of the fundamental frequency of an electrical power system. If, for example, the fundamental frequency is 50 Hz, then the 5th harmonic is five times that frequency, or 250 Hz. Likewise, the 7th harmonic is seven times the fundamental or 350 Hz, and so on for higher order harmonics. Harmonics can be discussed in terms of current or voltage. A 5th harmonic current is simply a current flowing at 250 Hz on a 50 Hz system. The 5th harmonic current flowing through the system impedance creates a 5th harmonic voltage. Total Harmonic Distortion (THD) expresses the amount of harmonics. The following is the formula for calculating the THD for current:

$$THD_{current} = \sqrt{\sum_{n=2}^{n=n} \left(\frac{I_n}{I_1}\right)^2} \times 100$$

Then...

$$I_{THD} = \sqrt{\left[\left(\frac{50}{250}\right)^2 + \left(\frac{35}{250}\right)^2\right]} \times 100 = 24\%$$

When harmonic currents flow in a power system, they are known as “poor power quality” or “dirty power”. Other causes of poor power quality include transients such as voltage spikes, surges, sags, and ringing. Because they repeat every cycle, harmonics are regarded as a steady-state cause of poor power quality.

When expressed as a percentage of fundamental voltage THD is given by,

where  $V_1$  is the fundamental frequency voltage and  $V_n$  is nth harmonic voltage component.

### Major Causes of Harmonics

Devices that draw non-sinusoidal currents when a sinusoidal voltage is applied create harmonics. Frequently these are devices that convert AC to DC. Some of these devices are listed below:

#### Electronic Switching Power Converters

- Computers, Uninterruptible power supplies (UPS), Solid-state rectifiers
- Electronic process control equipment, PLC's, etc

- Electronic lighting ballasts, including light dimmer
- Reduced voltage motor controllers

### **Arcing Devices**

- Discharge lighting, e.g. Fluorescent, Sodium and Mercury vapor
- Arc furnaces, Welding equipment, Electrical traction system

### **Ferromagnetic Devices**

- Transformers operating near saturation level
- Magnetic ballasts (Saturated Iron core)
- Induction heating equipment, Chokes, Motors

### **Appliances**

- TV sets, air conditioners, washing machines, microwave ovens
- Fax machines, photocopiers, printers

These devices use power electronics like SCRs, diodes, and thyristors, which are a growing percentage of the load in industrial power systems. The majority use a 6-pulse converter. Most loads which produce harmonics, do so as a steady-state phenomenon. A snapshot reading of an operating load that is suspected to be non-linear can determine if it is producing harmonics. Normally each load would manifest a specific harmonic spectrum.

Many problems can arise from harmonic currents in a power system. Some problems are easy to detect; others exist and persist because harmonics are not suspected. Higher RMS current and voltage in the system are caused by harmonic currents, which can result in any of the problems listed below:

1. Blinking of Incandescent Lights - Transformer Saturation
2. Capacitor Failure - Harmonic Resonance
3. Circuit Breakers Tripping - Inductive Heating and Overload
4. Conductor Failure - Inductive Heating
5. Electronic Equipment Shutting down - Voltage Distortion
6. Flickering of Fluorescent Lights - Transformer Saturation
7. Fuses Blowing for No Apparent Reason - Inductive Heating and Overload
8. Motor Failures (overheating) - Voltage Drop
9. Neutral Conductor and Terminal Failures - Additive Triplen Currents
10. Electromagnetic Load Failures - Inductive Heating
11. Overheating of Metal Enclosures - Inductive Heating

12. Power Interference on Voice Communication - Harmonic Noise

13. Transformer Failures - Inductive Heating

### **Overcoming Harmonics**

Tuned Harmonic filters consisting of a capacitor bank and reactor in series are designed and adopted for suppressing harmonics, by providing low impedance path for harmonic component.

