

Electrical Drives

(5th sem EE)

Prepared by
Sasmita Choudhury

MODULE-1

INTRODUCTION TO DRIVE SYSTEMS

Drives: Systems employed for motion control are called drives. Motion control is required in industrial as well as domestic applications like transportation system, rolling mills, paper mills, textile mills, machine tools, fans, pumps, robots, washing machines etc. Motion control may be translational, rotational or combination of both. Generally, a drive system is basically has a mechanical load, a transmission system and a prime mover. The prime mover may be I.C. engine, steam engine, turbine or electric motors. However, electric motors are predominantly used employed as prime mover due to certain advantages.

Advantages of Electric Drives:

- Flexible control characteristics.
- Starting and braking is easy and simple
- Provides a wide range of torques over a wide range of speeds (both ac and dc motor)
- Availability of wide range of electric power
- Works to almost any type of environmental conditions
- No exhaust gases emitted
- Capable of operating in all 4 quadrants of torque –speed plane
- Can be started and accelerated at very short time

Choice of Electrical Drives:

The choice of an electrical drive depends on a number of factors. Some important factors are:

- Steady state operation requirements: (nature of speed-torque characteristics, speed regulation, speed range, efficiency, duty cycle, quadrants of operation, speed fluctuations, rating etc)
- Transient operation requirement(values of acceleration and deceleration, starting, braking, speed reversing)
- Requirement of sources:(types of source, its capacity, magnitude of voltage, power factor, harmonics etc)
- Capital and running cost, maintenance needs, life periods
- Space and weight restrictions
- Environment and location
- Reliability

Basic Elements of the Electric Drive Systems:

Functional Block of Electric Drive System

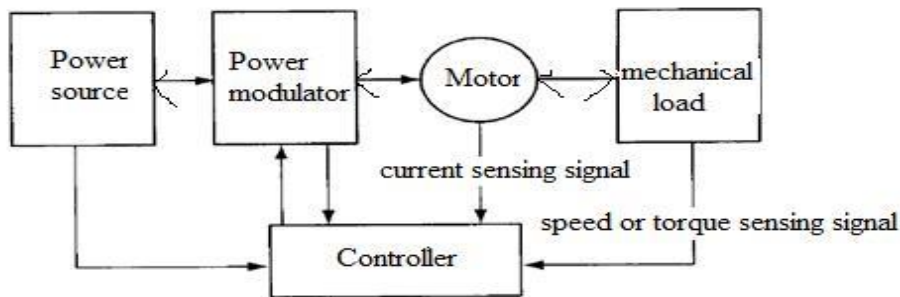

Fig 1.1

A modern electric drive system has five main functional blocks as shown above a mechanical load, a motor, a power modulator, a power source and a controller.

Power source: The power source provides the energy to the drive system. It may be dc or ac (single-phase or three-phase)

Power Converter: The converter interfaces the motor with the power source and provides the motor with adjustable voltage, current and frequency. During transient period such as starting, braking and speed reversal, it restricts source and motor current within permissible limits Also the converter converts the electric waveform into required signal that requires the motor. Types of modulator:

- Controlled Rectifier(ac to dc)
- Inverter (dc to ac)
- AC Voltage Regulator (ac to ac)
- DC Chopper (dc to dc)
- Cyclo-converter (ac to ac) (Frequency converter)

Controller:

A well designed controller has several functions. The basic function is to monitor system variables, compare them with desire values, and then adjust the converter output until the system achives a desired performance. This feature is used in speed and position control.

Electric motor: i) The basic criterion in selecting an electric motor for a given drive application is it meets power level and performance required by the load during steady state and dynamic operation.

ii) Environmental factors: In industry such as in food processing, chemical industries and aviation where the environment must be clean and free from arc. Induction motors are used instead of DC motor.

Mechanical Load:

The mechanical load usually called as machinery such as flow rates in pump, fans, robots, machine tools, trains and drills are coupled with motor shaft.

Classification of Load torque: Various load torques are broadly classified into two categories. A) Active Load Torque

B) Passive Load Torque

Load torques which have the potential to drive the motor under equilibrium conditions are called active load torques. Such load torques usually retain their sign when the direction of the drive rotation is changed. Torque due to the force of gravity, hoists, lifts or elevators and locomotive trains also torques due to tension, compression, and torsion undergone by an elastic body come under this category.

Components of the Load Torque (T_L) :

The load torque T_L can be further divided into the following components:

1. Friction torque T_F : The friction will be present at the motor shaft and also in the various parts of the load.
2. Windage torque T_W : When a motor runs, the wind generates a torque opposing the motion. This is known as the windage torque.
3. Torque required to do the useful mechanical work, T_M : The nature of this torque depends on the type of load. It may be constant and independent of speed, it may be some function of speed, it may be time invariant or time variant, and its nature may also vary with the change in the load's mode of operation.

The friction torque ' T_F ' can be resolved into three components as shown in figure 1.2b.

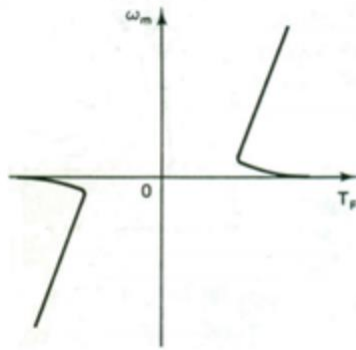

Fig 1.2 (a)

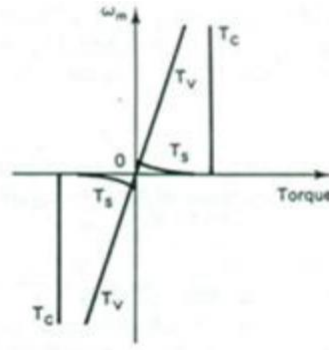

Fig 1.2 (b)

Friction torque and its components.

$$T_F = T_V + T_C + T_S \quad (1.1)$$

The first component T_V which varies linearly with speed is called viscous friction and is given by the following equation:

$$T_V = B\omega_m \quad (1.2)$$

where B is the viscous friction coefficient.

The windage torque T_w , which is proportional to speed squared, is given by the following equation:

$$T_w = C\omega_m^2 \quad (1.3)$$

where C is a constant.

So, $T_F = T_V + T_w$ is taken in account.

Now, the load torque can be represented by $T_L = T_M + T_V + T_w$

$$T = T_{LM} + Bw_m + Cw_m^2 \quad (1.4)$$

In many applications $T_w = Cw_m^2$ is very small compared to Bw_m and negligible compared to T_M . To simplify the analysis, the term T_w is neglected.

$$T_L = T_M + Bw_w \quad (1.5)$$

Torque-Speed Characteristics of Mechanical Load:

Fundamental Torque Equations

Mechanical load exhibit wide variations of speed-torque characteristics. Load torques are generally speed dependent and can be represented by an empirical formula such as

$$T = CT_r \left(\frac{n}{n_r} \right)^k \quad (1.6)$$

Where C is a proportionally constant, T_r is the load torque at the rated speed n_r , n is the operating speed, and k is an exponential coefficient representing the torque dependency speed. Figure shows the typical mechanical loads.

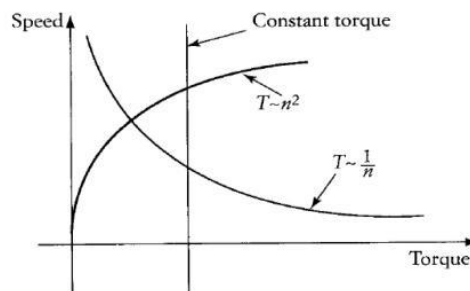

Typical speed-torque characteristics of mechanical loads

1. Torque independent of speed.

The characteristics of this type of mechanical load are represented by setting k is equal to zero and C equals to 1. While torque is independent of speed. Such examples are hoists, the pumping of water etc.

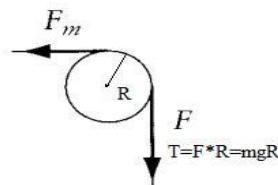

2. **Torque linearly dependent on speed.** The torque is linearly proportional to speed $k=1$, and the mechanical power is proportional to the square of the speed. An example would be a motor driving a dc generator connected to a fixed resistance load with constant field. It can be shown as

$$T = \frac{P}{w} \quad \text{where P is the power generated by generator} \quad (1.7)$$

But $P=VI$ and $T = \frac{P}{\omega} = \frac{VI}{R\omega} = \frac{k^2 \omega^2}{R\omega} = \frac{k^2 \omega}{R}$

$$T \propto \omega \quad (1.8)$$

$$\Rightarrow T \propto \omega \quad (1.9)$$

3. Torque proportional to the square of speed.

The torque-speed characteristic is parabolic, $k=2$. Such examples of loads are fans, centrifugal pumps, and propellers.

$$T \propto \omega^2 \quad (1.10)$$

4. Torque inversely proportional to speed.

In this case, $k=-1$. Examples are milling, boring machines, road vehicle and traction etc. $T \propto \frac{1}{\omega}$

$$T \propto \frac{1}{\omega} \quad (1.11)$$

Combined torque-speed characteristics of Motor-Load system:

Speed-torque characteristics of motor and mechanical load

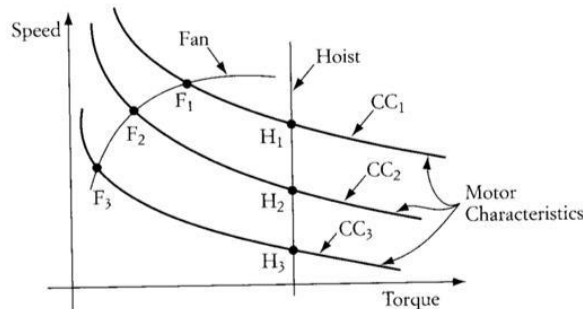

Dynamic of Motor-Load System:

Fundamental Torque Equations

The dynamic relations applicable to all types of motors and loads. The dynamic or transient condition. These condition appears during starting, braking and speed reversal of the drive.

A motor generally drives a load (machine) through some transmission system. While the motor always rotates, the load may rotate or may undergo a translational motion. It is convenient, however, to represent the motor load system by an equivalent rotational system, as shown in figure .

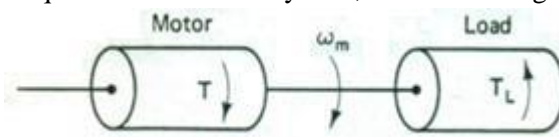

The following notations is adapted:

J = polar moment of inertia of the motor-load system referred to the motor shaft, Kg-

m^2 ω_m = instantaneous angular velocity of the motor shaft, rad/ sec

T_m = developed torque of the motor, N-m

T_L = the load (resisting) torque, referred to the motor shaft, N-m

Any motor-load system can be described by the following fundamental torque equation during dynamic condition:

$$T_m = T_L \mp dt^d (Jw_m) \quad (1.12)$$

$$\Rightarrow T_m = T_L \pm J \frac{dw_m}{dt} \quad (1.13)$$

This equation is applicable for variable inertia drives such as mines winder, industrial robots etc.

$$\text{And } T_m = T_L \pm J \frac{dw_m}{dt} \quad (1.14)$$

This equation is for constant inertia i.e. $\frac{dJ}{dt} = 0$

negative sign for deceleration and positive sign for acceleration.

Acceleration or deceleration depends on whether T_m is greater or less than T_L . During acceleration, motor should supply not only load torque T_L but also an additional torque component called inertia torque

$J \frac{dw_m}{dt}$ to overcome the drive inertia. During deceleration, dynamic torque $J \frac{dw_m}{dt}$ has negative sign.

Therefore, it assists the motor torque T_m and maintains drive motion by extracting from stored kinetic energy.

The fundamental torque equation balance between the various torques in the drive may be considered while investigating the dynamic behavior is

$$T_m = T_L + J \frac{dw_m}{dt} \quad (1.15)$$

$$\text{Where, } T_L = T_M + Bw_w \quad (1.16)$$

It is seen from the above equation that, when

$$\text{i) } T_m > T_L \quad \text{i.e.} \quad \frac{dw_m}{dt} > 0 \quad (1.17)$$

the drive will be accelerating, in particular, picking up speed to reach rated speed

$$\text{ii) } T_m < T_L \quad \text{i.e.} \quad \frac{dw_m}{dt} < 0 \quad (1.18)$$

the drive will be decelerating and particularly, coming to rest

$$\text{iii) } T_m = T_L \quad \text{i.e.} \quad \frac{dw_m}{dt} = 0 \quad (1.19)$$

the motor will continue to run the same speed, if it were running or will continue to be at rest, if it were not running.

Stability:

Steady State Stability

A) Transient state Stability or Dynamic Stability

Criteria for Steady State Stability:

Let us assume that the motor-load speed-torque curve is at in equilibrium i.e. at steady state.

The disturbances changes the equilibrium states. The disturbances are two types. Such as

1. Due to slow change of inertia of rotating masses or that of inductances changes the equilibrium states slowly. So, effect of the inertia and the inductances are neglected for dynamics.

2. Due to large and sudden changes of inertia and inductances there is a sudden changes of equilibrium states. So, the inertia and inductances are taken for dynamic study.

Study of stability under conditions given above for the first type of disturbance relate to the field of steady state stability while for the second type of disturbance pertain to the field of dynamic or transient stability.

Let the equilibrium values of the torques and speed be denoted by T_m, T_L and w_m

Then at equilibrium, when deviation is not occurred

$$T_m = T_L \quad (1.20)$$

Let a small deviation in load torque is done, so that all equilibrium changes by $\Delta T_m, \Delta T_L$ and Δw_m

$$\text{then, the dynamics } T_m = T_L + J \frac{dw_m}{dt} \text{ becomes } T_m + \Delta T_m = T_L + \Delta T_L + J \frac{d(w_m + \Delta w_m)}{dt} \quad (1.21)$$

$$\Rightarrow \Delta T_m = \Delta T_L + J \frac{d\Delta w_m}{dt} \quad (1.22)$$

If we assume that these increments are so small that may be expressed as linear functions of the change in speed, then

$$\Delta T_m = \frac{dT_m}{dw_m} \Delta w_m \quad (1.23)$$

$$\Delta T_L = \frac{dT_L}{dw_m} \Delta w_m \quad (1.24)$$

Where $\frac{dT_m}{dw_m}$ and $\frac{dT_L}{dw_m}$ indicates derivatives at the point of equilibrium. Substituting these relations in early equation and rearranging, we have

$$J \frac{d\Delta w_m}{dt} + \left(\frac{dT_m}{dw_m} - \frac{dT_L}{dw_m} \right) \Delta w_m = 0$$

$$\Delta w_m = (\Delta w_m)_0 e^{-\frac{t}{\tau}} \quad (1.25)$$

$$\tau = \frac{J}{\left(\frac{dT_m}{dw_m} - \frac{dT_L}{dw_m} \right)} \quad \text{called mechanical time constant.}$$

For the system to be stable when the exponent of the equation be negative. This exponent will be negative when

$$\frac{dT_L}{dw_m} - \frac{dT_m}{dw_m} > 0 \quad (1.26)$$

$$\text{or} \quad \frac{dT_L}{dw_m} > \frac{dT_m}{dw_m} \quad (1.27)$$

Transient state stability:

Concept of Transient Stability

Thus the equation of motion in terms of power, can be written as

$$P_m = P_{dyn} + P_L \quad (1.28)$$

Where P_m , P_{dyn} and P_L denote the motor power, dynamic power and the load power at the shaft respectively. The dynamic power is determined from the angular acceleration. Let the angular position of the shaft at any instant is taken as the δ between a point and reference which is rotating at synchronous speed. With sudden application of load, since the rotor slows down, the angular acceleration will be negative and hence the dynamic power will be given by

$$P_{dyn} = -P_j \frac{d^2\delta}{dt^2} \quad (1.29)$$

$$\text{Where, } P_j = J * \omega * \frac{2}{\text{Poles}} \quad (1.30)$$

The electromagnetic power P_m has two components (i) damping power which linearly varies with $\frac{d\delta}{dt}$ from synchronous speed and (ii) Synchronous power which is a function of load angle δ . Thus,

$$P_j \frac{d^2\delta}{dt^2} + P_d \frac{d\delta}{dt} + P(\delta) = P_L \quad (1.31)$$

Where, P_d is the damping power. Neglecting damping and assuming cylindrical rotor, then the above equation will be

$$P_j \frac{d^2\delta}{dt^2} + P_m \sin \delta = P_L \quad (1.32)$$

$$\text{Where, } P_m = \frac{VE}{X_s}$$

$$\text{Now, } \frac{d^2\delta}{dt^2} = \frac{P_L - P_m \sin \delta}{P_j} \quad (1.33)$$

Multiplying both sides by $\frac{d\delta}{dt}$, we have

$$\frac{d^2\delta}{dt^2} \left(\frac{d\delta}{dt} \right) = \left(\frac{P_L - P_m \sin \delta}{P_j} \right) \frac{d\delta}{dt}$$

$$\frac{d\delta}{dt} = \sqrt{\int_{\delta_0}^{\delta} \frac{2(P - P_m \sin \delta)}{P_j} d\delta} \quad (1.34)$$

Where δ_0 is the load angle before the disturbance, i.e., at time $t=0$. So, for the machine to be stable at the synchronous speed $\frac{d\delta}{dt} = 0$. Hence,

$$\sqrt{\int_{\delta_0}^{\delta} \frac{2(P - P_m \sin \delta)}{P_j} d\delta} = 0 \quad (1.35)$$

$$\int_{\delta_0}^{\delta} (P_L - P_m \sin \delta) d\delta \quad (1.36)$$

With the motor initial load P_{L1} , the operating point is at A corresponding to point δ_0 . As the load is suddenly increased to P_{L2} , the power angle swings to δ_f at which the speed is again synchronous. When

$$\int_{\delta_0}^{\delta_i} (P_{L2} - P_m \sin \delta) d\delta + \int_{\delta_i}^{\delta_f} (P_{L2} - P_m \sin \delta) d\delta = 0 \quad (1.37)$$

where δ_i is the power angle corresponding to new load P_{L2} . So, from the equation it is to be written as

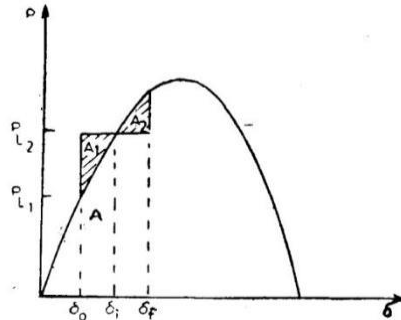

$$\int_{\delta_0}^{\delta_i} (P_{L2} - P_m \sin \delta) d\delta = \int_{\delta_i}^{\delta_f} (P_m \sin \delta - P_{L2}) d\delta \quad (1.38)$$

Or Area $A_1 = A_2$. This method of determining the transient stability of a drive system is called equal area criterion of stability.

Conclusion :

- i) If area $A_1 > A_2$, the drive is stable
- ii) If area $A_1 = A_2$, the drive is just stable
- iii) If $A_1 < A_2$, the motor loses synchronism

Rating of Motor:

From the classes of duty the motor rating is selected. A motor can be selected for a given class of duty based on its thermal rating with due consideration to pull out torque i.e. the overload must be within the pull out torque. The various classes of duties are

- Continuous duty

- Intermittent duty
- Short time duty

Continuous duty: Two classes of continuous duty are there. a) continuous duty at constant load b) continuous duty with variable load

- i) continuous duty at constant load: It denotes the motor operation at a constant load torque for a long duration enough to attain the steady state temperature. Ex. Paper mill drives, centrifugal pumps and fans etc. Frequent starting is not required. The rating of the machine is decided by input power.

If efficiency of the load and transmission is η , the input power to the load is

$$P = \frac{wT}{\eta} \quad (\text{for rotational body}) \quad (1.39)$$

T= load torque

$$P = \frac{F * V}{0.201 * \eta} \quad (\text{for linear motion}) \quad (1.40)$$

F= force exerted by load in kg

V= velocity of motion in m/sec

$$P = \frac{F * V}{2 * 0.102 * \eta} \quad (\text{for elevator}) \quad (1.41)$$

$$P = \frac{HQ\rho}{0.102 * \eta} \quad (\text{for pump}) \quad (1.42)$$

H= gross head comprising suction in mt

Q= quantity of delivery of pump in mt³/sec

ρ = density of liquid in kg/mt³

$$P = \frac{HQ}{0.102 * \eta} \quad (\text{for fan}) \quad (1.43)$$

Q=volume of air in mt³/sec

H= pressure of air in kg/mt²

- ii) continuous duty with variable load: Load has several steps in one cycle. The motor rating is neither selected for highest load nor lowest load rather the rating is selected on average losses for the load cycle. Ex. Metal cutting lathes, conveyors etc.

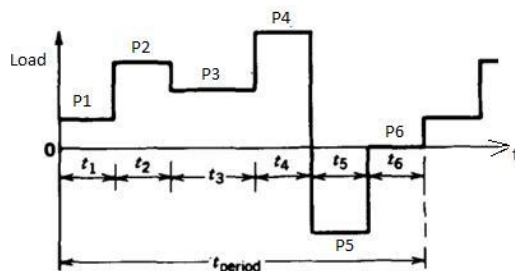

For variable motor mechanical load, the current to the motor is variable. To find the rating of the motor the equivalent current I_{eq} method is used for finding the motor rating.

Let each step of the load the power loss is composed of constant loss which is independent of load called core and variable loss called copper loss. The variable load consists of motor current I_1, I_2, \dots, I_6 for one cycle. Thus

$$P_{ceq} = \frac{(P + I_1^2 R)t + (P + I_2^2 R)t + \dots + (P + I_6^2 R)t}{t_1 + t_2 + \dots + t_6}$$

$$I_{ceq} = \sqrt{\frac{I_1^2 t_1 + I_2^2 t_2 + \dots + I_6^2 t_6}{t_1 + t_2 + t_3 + \dots + t_6}} \quad (1.44)$$

After I_{ceq} is determined, a motor with next higher current rating ($= I_{rated}$) from commercially available ratings is selected.

DC motor: For the design of dc motor, the maximum allowable current is 2 times the rated current.

Induction and Synchronous motor: Here the maximum breakdown torque to rated is 2 to 2.25

Short Time Duty: In short time duty, the time of operation is less than the heating time constant and the motor is allowed to cool down to the ambient temperature before it is required to start again. If a motor rating of power P_r is subjected to short time duty load of KP_r , then the temperature rise will be far below than the permissible temperature θ_{per} . Therefore, the motor can be overloaded by a factor $K > 1$ such that, the maximum temperature rise just reaches the permissible value θ_{per} . Now, for the load KP_r , the time of operation is t_r .

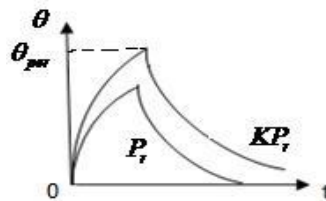

$$\theta_{per} = \theta_{ss} (1 - e^{-\frac{t_r}{\tau}}) \quad (1.45)$$

$$\frac{\theta_{per}}{\theta_{ss}} = \left(\frac{1}{1 - e^{-\frac{t_r}{\tau}}} \right)$$

For motor power P_r (the loss is P_{lr})
 For power KP_r , the loss is $\frac{1}{1 - e^{-\frac{t_r}{\tau}}} P_{lr}$, then $\frac{\theta_{ss}}{\theta_{per}} = \frac{P_{lr}}{P_{lr}}$

But, $P_{lr} = P + P_{ccu}$ and let $\alpha = \frac{P_c}{P}$

$$\text{then, } P_{lr} = P + P \left(\frac{KP_r}{P_r} \right)^2 = P + K^2 P = P(\alpha + K^2) \quad (1.46)$$

From the equations, the overloading factor $K = \sqrt{\frac{1+\alpha}{1 - e^{-\frac{t_r}{\tau}}} - \alpha}$ (1.47)

Intermittent periodic duty: Here, the temperature neither reaches the steady state value during on nor reaches to ambient temperature during off period. So, the over-loading can be applied to the motor to bring to the steady state temperature for which the motor rating can be selected. The overloading factor can be found as

$$K = \sqrt{(\alpha + 1) \frac{1 - e^{-\left(\frac{t_r}{\tau}\right) \ln\left(\frac{T_{lh} - T_{min}}{T_{lh} - T_{min}}\right)}}{1 - e^{-\frac{t_r}{\tau}}} - \alpha}$$
 (1.48)

Load Equalization:

In application such as electric hammer, pressing job, steel rolling mills etc, load fluctuates widely within short intervals of time. In such drives, to meet the required load the motor rating has to be high or the motor would draw the pulse current from the supply. Such pulse current from the supply gives voltage fluctuations which affects to the other load connected to it and affects to the stability of the source. The above problem can be met by using a flywheel connected to the motor shaft for non-reversible drives. This is called load equalization. The moment of inertia and the mechanical time constant can be found out from the load equalization problem.

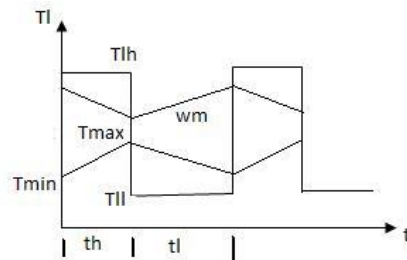

$$J = \frac{I_r}{w_{no} - w_{mr}} \left(\frac{t_l}{\ln \left(\frac{T_{lh} - T_{min}}{T_{lh} - T_{min}} \right)} \right) \quad \text{or} \quad J = \frac{I_r}{w_{no} - w_{mr}} \left(\frac{t_h}{\ln \left(\frac{T_{lh} - T_{min}}{T_{lh} - T_{min}} \right)} \right)$$
 (1.49)

The mechanical time constant is

$$\tau_m = \left(\frac{t_h}{\ln \left(\frac{T_{lh} - T_{min}}{T_{lh} - T_{min}} \right)} \right)$$
 (1.50)

The symbols used have their respective meaning.

Bidirectional Electrical Drives (1st and 2nd quadrant)

From the action-reaction theory of Newton’s Law, when an electric motor driving a mechanical load in a steady state operation, a force exerted by either part (motor or load) of drive system, is opposed by a force equal in magnitude and opposite in direction from the other. This can be understood by taking a bidirectional drives with **unidirectional speed and bidirectional load torque.**

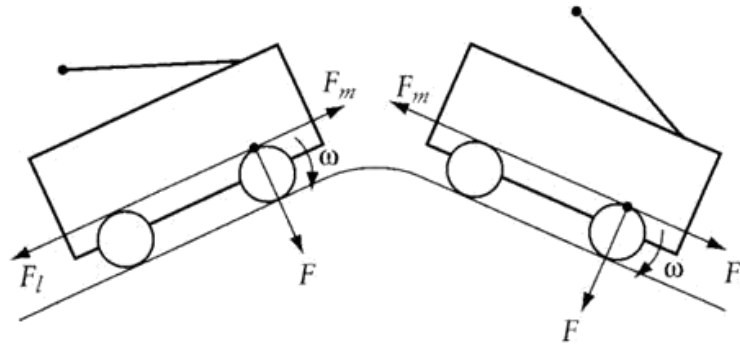

Bi-directional speed drive (1st and 4th quadrant)

In the figure shown below an elevator is moving passengers in both directions (up and down). For simplicity, let us assume that the elevator does not have a counterweight. In the upward directions, the motor sees the load force F_l which is a function of the weight of the passengers plus elevator cabin, cable etc. Since the weight and F_l are unidirectional, the motor force F_m is also unidirectional. The speed of the motor in this operation is bidirectional.

Bidirectional speed

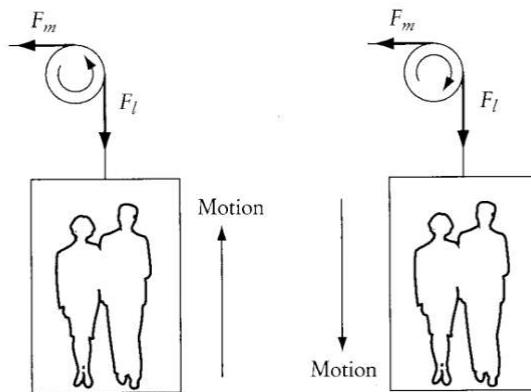

Four-Quadrant Drives

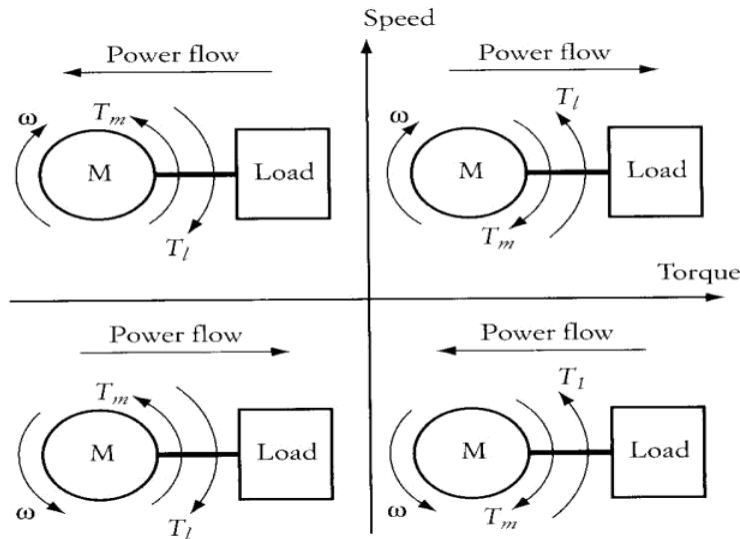

The Following conventions are to be followed.

1. When the torque of an electric machine is in the same direction as system speed, the machine consumes electric power from the source and deliver the mechanical power to the laod. The machine is then operating as a motor.
2. If the speed and the torque of the machine are in opposite directions, the machine is consuming mechanical power from the load and delivering electric power to the source. In this case, the machine is acting as generator.

Characteristics of Motor:

Three types of electric motors generally used for drive purposes. DC, Induction and Synchronous motor.

DC Drives:

Separately Excited Dc motor:

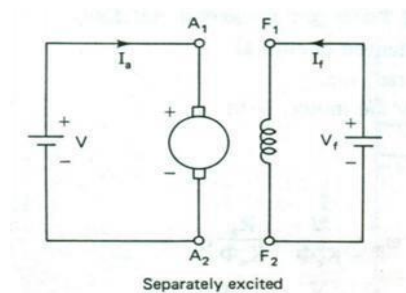

The basic equations for DC motor are

$$E = K_e \phi \omega_m \quad (1.51)$$

$$V = E + I_a R_a \quad (1.52)$$

$$T = K_e \phi I_a \quad (1.53)$$

Where, E = back emf in volt; ϕ = flux per pole in weber; V = supply voltage in volt; I_a = Armature current in Amp; R_a = Armature resistance in ohm; ω_m = speed of armature in rad/sec; T = torque developed in motor in N-mt

From the above set of steady state equations the steady state torque speed relation can be found out as

$$w_m = \frac{V}{K_e \phi} - \frac{I_a R_a}{K_e \phi} \quad (1.54)$$

$$w_m = \frac{V}{K_e \phi} - \frac{R_a T}{(K_e \phi)^2} \quad (1.55)$$

This equation can be applied to all series, shunt, compound and separately excited dc motors.

In the case of separately excited motors, if the field voltage is maintained constant, and assuming the flux as constant, then

$$K_e \phi = K \text{ (constant)} \quad (1.56)$$

The speed equation is written for the separately as well as shunt motor is

$$w_m = \frac{V}{K} - \frac{R_a T}{K^2} \quad (1.57)$$

The speed increases from the zero upto the base speed. This method is called the constant torque method. Beyond the rated voltage, and rated armature current the voltage can not be increased further due to insulation problem. So, to control the speed the flux control can be done. By decreasing the flux, speed can be increased above the base speed w_{m0} . This method is called constant power method where both voltage and armature current is kept constants. Further, in the below base speed region, the speed can be decreased from the no load speed w_{m0} by increasing the load. When the load increased, the speed decreased from its no load speed. This motor is used where the speed regulation is good.

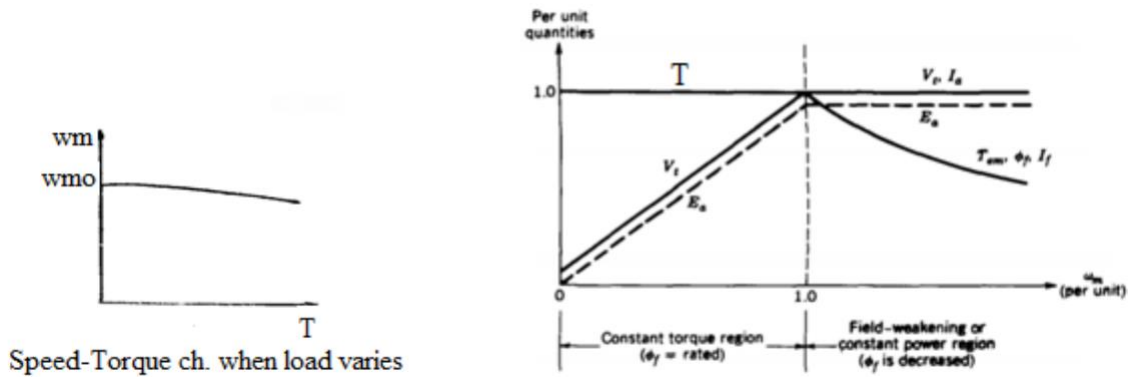

Dc Series Motor:

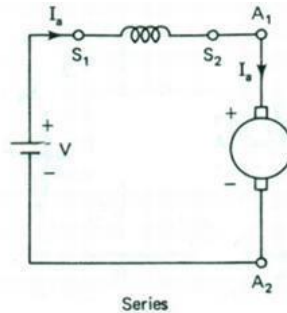

From the basic equation the speed can be written as

$$w_m = \frac{V}{K_e \phi} - \frac{R_a T}{(K_e \phi)^2}$$

In series motor, $T = K_e \phi I_a$, but $\phi \propto I_a$

So, $T = K_e K_f I_a^2$ (1.58)

$$\omega_m = \frac{V}{\sqrt{K_e K_f}} \frac{1}{\sqrt{T}} - \frac{R_a}{K_e K_f}$$
 (1.59)

In the case of series motor, any increase in torque is accompanied by an increase in the armature current and therefore, an increase in flux. Because the flux increases with torque, the speed must drop to maintain a balance between the induced voltage and the supply voltage. The characteristic is therefore, highly drooping.

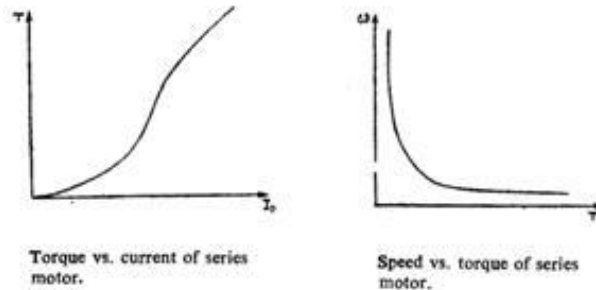

Methods of speed control

From the speed-torque relation from the equation it is seen that, the speed can be controlled by any one of the following three methods.

1. Armature voltage control
2. Armature resistance control (Rheostatic control)
3. Field flux control

Armature voltage control method: (DC shunt motor)

The speeds corresponding to two different armature voltages are V_1 and V_2 of a dc shunt motor are given by

$$\omega_{m1} = \frac{V_1}{K_e \phi} - \frac{R_a T}{(K_e \phi)^2} = \omega_{10} - \Delta \omega$$
 (1.60)

$$\omega_{m2} = \frac{V_2}{K_e \phi} - \frac{R_a T}{(K_e \phi)^2} = \omega_{20} - \Delta \omega$$
 (1.61)

The no load speed is directly proportional to the supply voltages. Keeping the load torque as constant, the family of motor torque-speed characteristics can be drawn for a given load torque.

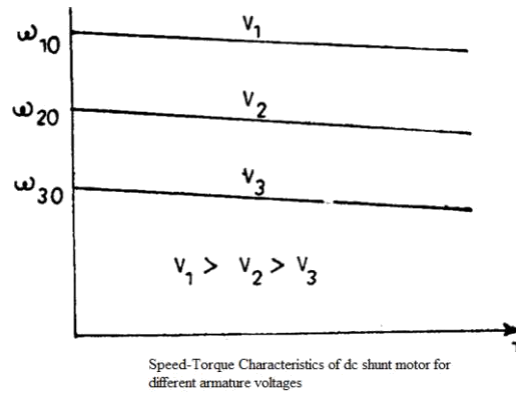

This method is only for below rated speed since the voltage magnitude should not be greater than the rated voltage. The variable voltages can be obtained by phase controlled rectifier and DC-DC Chopper converter.

DC Series motor:

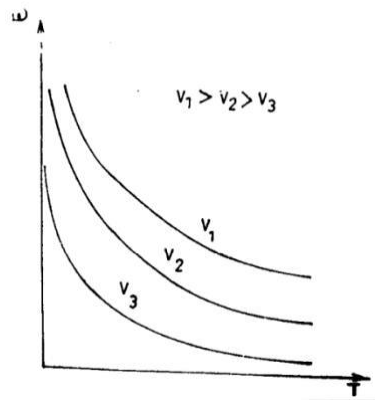

Field flux control method.

If the field of a separately or series excited motor running at a speed is weakened, its induced emf decreases. Because of low armature resistance, the current increases by an amount much larger than the decrease in the field flux. As a result, in spite of the weakened field, the torque is increased by a large amount, considerably exceeding the load torque. The surplus torque thus available causes the motor to accelerate and the back emf to rise. The motor will finally settle down to a new speed, higher than the previous one, at which the motor torque with the weakened field becomes equal to the load torque. Any attempt to weaken the field by a large amount will cause a dangerous inrush of current. Care should therefore be taken to weaken the field only slowly and gradually.

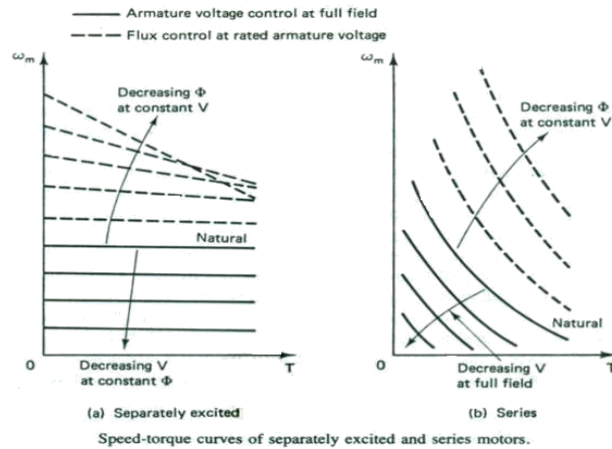

Armature resistance control:

Speed torque characteristics of separately excited (or shunt) and series motors for various values of external resistance R_e in series with the armature are shown.

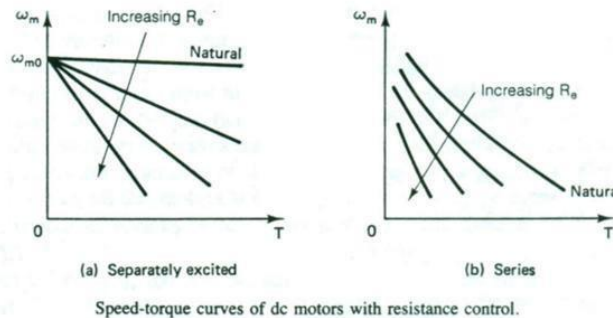

The main drawback of this method of speed control is its poor efficiency. Because of the poor efficiency, this method is seldom used with separately excited motors, except for getting speeds which are required for very short times.

Braking:

There are three methods of braking a dc motor

1. Regenerative braking.
2. Dynamic braking or rheostatic braking.
3. Plugging or reverse voltage braking

Regenerative Braking:

In regenerative braking, the energy generated is supplied to the source.

Separately Excited Motor:

The steady-state equivalent circuit of a separately excited motor and source is given in figure. If by some method the induced emf E is made greater than the source voltage V , the current will reverse. The machine will work as a generator and the source will act as a sink of energy, thus giving regenerative braking.

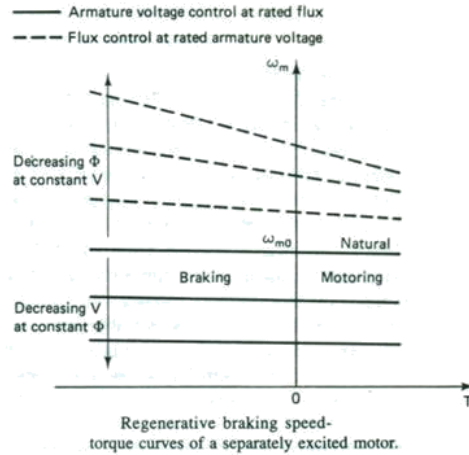

Series motor

Series motors cannot be used for regenerative braking in the same simple way as separately excited motors. For the regenerative braking to take place, the motor induced emf must exceed the supply voltage and the armature current should reverse. The reversal of armature current will reverse the current through the field, and, therefore, the induced emf will also reverse. The main advantage of regenerative braking is that the generated electrical energy is usefully employed instead of being wasted in rheostats as in the case of dynamic braking and plugging.

Dynamic Braking:

The dynamic braking of a dc motor is done by disconnecting it from the source and closing the armature circuit through a suitable resistance. The motor now works as a generator, producing the braking torque. For the braking operation, the separately excited (or shunt) motor can be connected either as a separately excited generator (fig.b), where the flux remains constant, or it can be connected as a self-excited shunt generator, with the field winding in parallel with the armature (fig.c).

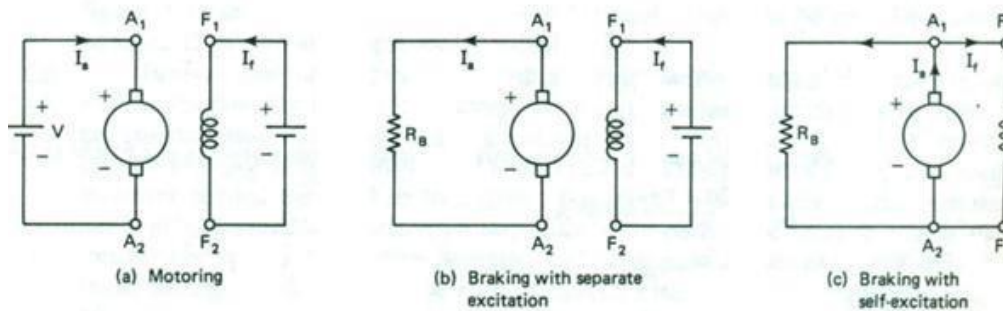

Dynamic braking of separately excited motor.

Series Motor:

For dynamic braking, the series motor is usually connected as a self-excited series generator. For the self-excitation, it is necessary that the current forced through the field winding by the induced emf aids the residual flux. This requirement is satisfied either by reversing the armature terminals or the field terminals.

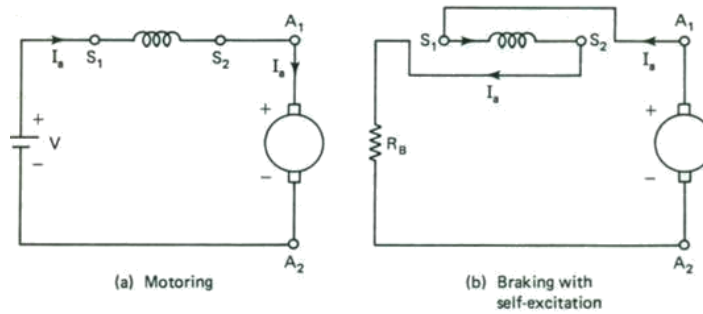

Dynamic braking of series motor.

Speed-Torque Characteristics during dynamic braking:

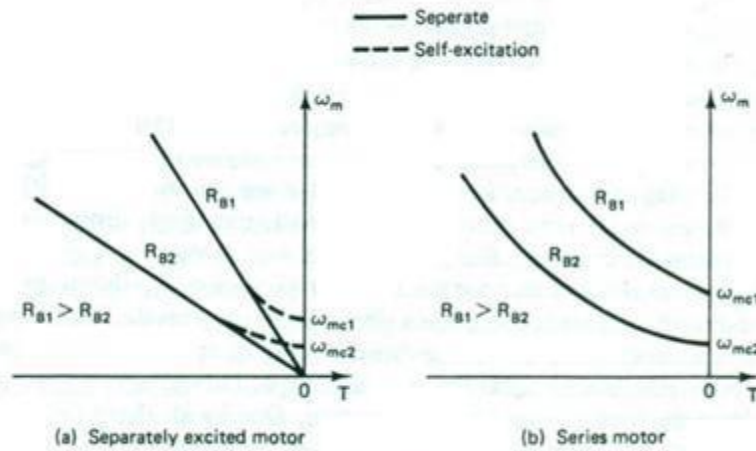

Speed-torque curves of dc motors under dynamic braking.

Plugging:

If the armature terminals (or supply polarity) of a separately excited (or shunt) motor when running are reversed, the supply voltage and the induced voltage will act in the same direction and the motor current will reverse, producing braking torque. This type of braking is called plugging. In the case of a series motor, either the armature terminals or field terminals should be reversed. Reversing of both gives only the normal motoring operation.

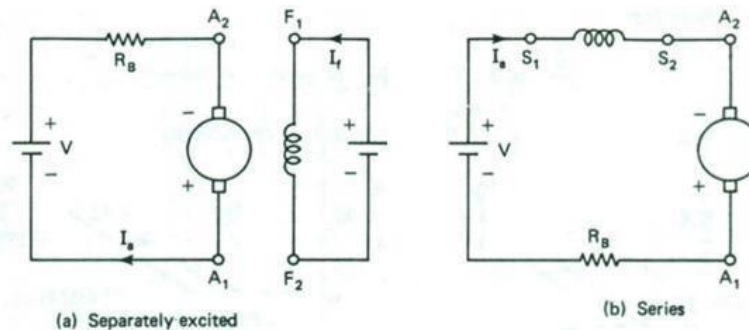

Plugging operation of dc motors.

Torque-speed characteristics:

When running at the rated speed, the induced voltage will be nearly equal to the supply voltage V . Therefore, at the initiation of braking, the total voltage in the armature circuit will be nearly $2V$. To limit the current within the safe value, a resistance equal to twice the starting resistance will be required.

Plugging is a highly inefficient method of braking. Not only is power supplied by the load, but also the power taken from the source is wasted in resistances.

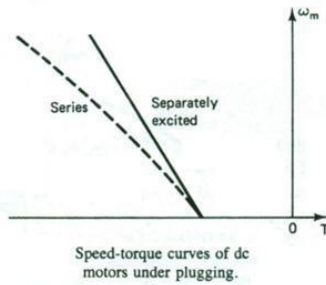

Starting:

Separately excited dc motor:

The maximum current that a dc motor can safely carry during transients of short duration is limited by the maximum armature current that can be commutated without sparking. From the speed equation we see

$$\omega_m = \omega_0 - \Delta\omega$$

For large motors (greater than 10hp), the armature resistance R_a is very small. For these motors, the speed drop $\Delta\omega$ is very small, and the machine is considered to be constant speed machines. The torque developed at starting T_{st} and starting current I_{st} can be calculated by keeping speed as zero during starting.

$$\frac{V}{K\phi} = \frac{R_a I_{st}}{(K\phi)^2} \tag{1.62}$$

$$\Rightarrow T_{st} = (K\phi) \frac{V}{R_a} \tag{1.63}$$

The starting current is $I_{st} = \frac{V}{R_a}$ (1.64)

Effect of reducing source voltage during starting.

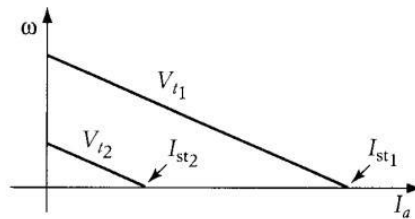

Effect of reducing external resistances.

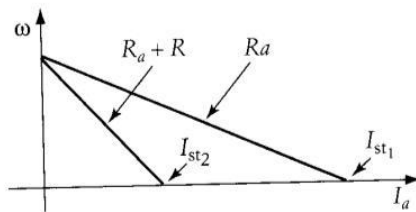

Series Motor:

In series motor, the starting current is less due to presence of field resistances in series with armature resistance.

$$I_{st} = \frac{V}{R_a + R_f} \quad (1.65)$$

$$T_{st} = KC \left(\frac{V}{R_a + R_f} \right)^2 \quad (\text{series motor}) \quad (1.66)$$

$$T_{st} = KC \left(\frac{V}{R_a} \right) \left(\frac{V}{R_{fs}} \right) \quad (\text{shunt motor}) \quad (1.67)$$

From the two equations it is seen that,

T_{st} is less in shunt motor and more in series motor.

I_{st} is more in shunt motor and less in series motor. So, series motor is widely used in traction drive.